

5.21i Elliptical Fitness Crosstrainer

Warning: This service manual is for use by Precor trained service providers only. If you are not a Precor Trained Servicer, you must not attempt to service any Precor Product; Call your dealer for service.

This document contains information required to perform the majority of troubleshooting, and replacement procedures required to repair and maintain this product.

This document contains general product information, software diagnostic procedures (when available), preventative maintenance procedures, inspection and adjustment procedures, troubleshooting procedures, replacement procedures and electrical block and wiring diagrams.

To move directly to a procedure, click the appropriate procedure in the bookmark section to the left of this page. You may “drag” the separator bar between this page and the bookmark section to change the size of the page being viewed.

Section One - Things You Should Know

Right, Left, Front, and Back Conventions

In this manual, right, left, front, and back are from the perspective of a user standing on the EFX 5.21i, facing the display enclosure.

Warning and Caution Statements and General Safety Guidelines

Warning statements indicate a particularly dangerous activity. Warning statements you will find in this manual include:

- To remove power from the EFX 5.21i, the power cord must be disconnected from the wall outlet. Always ensure that the EFX 5.21i is unplugged from the wall outlet when you inspect or adjust the EFX 5.21i, or when you isolate, remove, or replace a EFX 5.21i component.
- Removing the covers exposes high voltage components and potentially dangerous machinery. Exercise extreme caution when you perform maintenance procedures with the hood removed.
- During service operations you will be very close to moving machinery and high voltage components. When you perform maintenance procedures with the covers removed, remove jewelry (especially from ears and neck), tie up long hair, remove neck ties, and do not wear loose clothing.
- Exercise caution when touching any wire or electrical component during EFX 5.21i operation.

Caution statements are intended to prevent damage to the EFX 5.21i as a result of the current activity. Caution statements included in this manual are listed below:

- Notice the orientation notch on the PROM. These components must be positioned with the same notch orientation.

Safety guidelines you should know and follow include:

- Read the owner's manual and follow all operating instructions.
- Visually check the EFX 5.21i before beginning service or maintenance operations. If it is not completely assembled or is damaged in any way, exercise extreme caution while operating and checking the EFX 5.21i.
- When operating the EFX 5.21i, do not wear loose clothing. Do not wear shoes with heels or leather soles. Check the soles of your shoes and remove any embedded stones. Tie long hair back.
- Do not rock the unit. Do not stand or climb on the handlebars, display enclosure, or cover.

- Do not set anything on the handlebars, display enclosure, or cover. Never place liquids on any part of the EFX 5.21i other than a water bottle in the water bottle holder during normal operation.
- To prevent electrical shock, keep all electrical components, such as the power cord and circuit breaker away from water and other liquids.
- Do not use accessory attachments that are not recommended by the manufacturer-such attachments might cause injuries.

General Information

For the latest exploded view, part number and part pricing information, visit the Precor dealer website at www.precor.com/connection.

Required Tools and Equipment

The following list is a summary of the tools and equipment required when you service Precor's EFX 5.21i.

TOOLS

phillips and flat-head screwdrivers
standard and metric allen wrench sets
open-end wrench set
drive ratchet and ratchet set
socket drive allen set
chip puller
rubber mallet
snap ring pliers
100 ft./lb. torque wrench
300 in./lb. torque wrench
belt gauge (part # 20030-117)

EQUIPMENT

anti-static wrist strap (20024-101)
digital multimeter

Supplies

blue loctite
cable ties

Spares

interconnect cables

Procedure 2.1 - Accessing the Diagnostic Program

The EFX 5.21i diagnostic software cycles through the following tests:

- Display Test
- Keyboard Test
- Heart Rate Test
- Lift A/D Test
- Brake (eddy current) Test

Procedure

1. Plug the power cord into the wall outlet, then turn on the EFX 5.21i with the on/off switch.

Note:

For the purpose of entering the key sequences to access the various diagnostic programs, the keypad keys are hypothetically numbered from 1 to 7 from left to right.

2. With the **PRECOR EFX 5.21i** banner displayed, access the diagnostic program by pressing, keys **RESET,5,1,7,6,5,7,6,1**, sequentially.

Diagram 2.1 - 5.21i Display

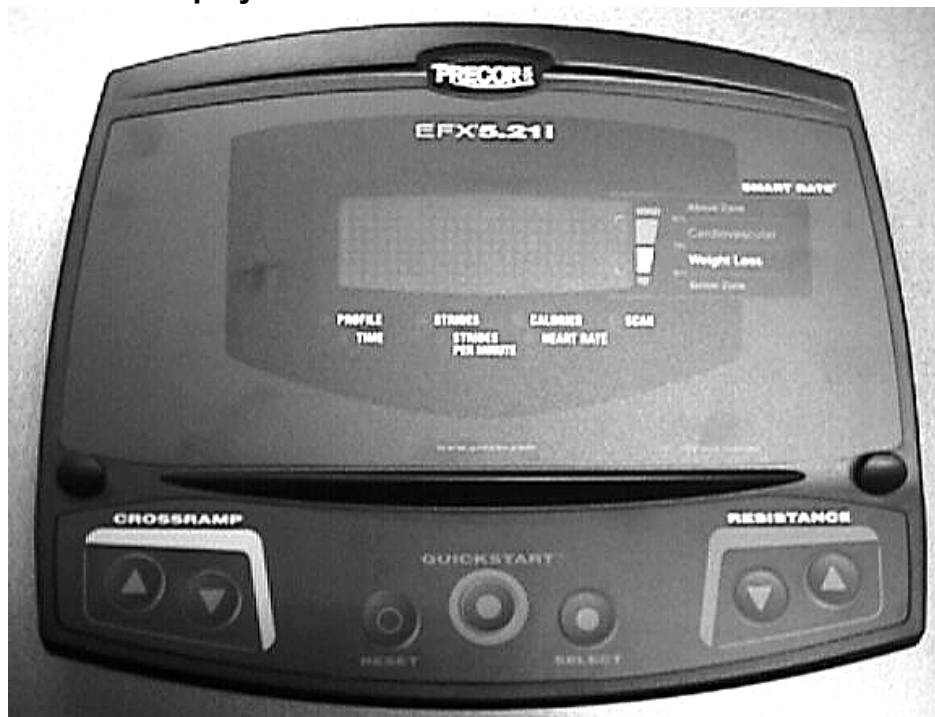

3. Watch the display as the LED test progresses. The test is programmed to display the following LED illumination sequence:
 - a. The test name "**DISPLAY TEST**" will be scrolled.
 - b. All of the L.E.D.s on the display will be illuminated.
3. Press the **RESET** key to proceed to the keyboard test.
4. The test name "**KEYBOARD TEST**" will be scrolled.
5. A graphical representation of all the keys on the keyboard will be displayed. When a key is pressed the representation of the key will become a single dot. Check all of the keys on the keyboard in this manner.
6. Press and hold the **RESET** key for a minimum of 2 seconds to proceed to the heart rate test.
7. The test name "**HEART RATE TEST**" will be scrolled.
8. A chest strap heart rate transmitter or a heart rate test transmitter must be used in conjunction with this test.
9. When a heart rate signal is received, the Polar heart rate will be displayed as "**P XXX**" and the **SCAN** L.E.D. will flash in time with the heart rate.
10. Press the **RESET** key to proceed to the lift test.
11. The test name "**LIFT A/D**" will be displayed for 2 seconds.
12. The lift calibration number will be displayed on the right. The lift calibration number indicates the physical position of the incline and is used to calibrate the lift motor.
13. Press the **RESET** key to proceed to the brake test.
14. The test name "**BRAKE**" will be displayed for 2 seconds.
15. The resistance level will be displayed on the left side of the display and the corresponding power bits (duty cycle) will be displayed on the right side of the display. Initially, the power bits level will be zero, pressing the ▲, ▼ keys will change the number of power bits being applied to the eddy current system.
16. Press the **RESET** key to exit the diagnostics program.

Procedure 2.2 - Accessing the Information Display

Procedure

1. Plug the power cord into the wall outlet, then turn on the EFX 5.21i with the on/off switch.
2. With the **PRECOR EFX 5.21i** banner displayed, press keys **RESET,6,5**, sequentially.

The EFX 5.21i Information display cycles through the following displays:

- a. Odometer
 - b. Hour meter
 - c. Software version
 - d. Error log
5. The display name "**ODOMETER**" will be displayed for 2 seconds. Then the odometer value will be displayed, as total strides accumulated.
 6. Press the **ENTER** key to proceed to the hour meter display.
 7. The display name "**HOUR METER**" will be displayed for 2 seconds. Then the hour meter value will be displayed, as the total number of hours of use. Fractional parts of an hour are stored internally, the display will be truncated to the nearest full hour.
 8. Press the **ENTER** key to proceed to the software version display.
 9. The display name "**SW VERSION**" will be displayed for 2 seconds.
 10. The upper software version (**UPPER X.XX**) will be displayed. Pressing either **SELECT** key will toggle between the upper and lower software version display.
 11. Press the **ENTER** key to proceed to the error log display
 12. The display name "**ERROR LOG**" will be displayed for 2 seconds.
 13. The first error log entry will be displayed (**1: ERXX**).
 14. Pressing the **▲**, **▼** keys will move you through the log entries. Entry 1 will be the most recent error log entry, with each succeeding entry being older than the preceding entry.
 15. Pressing the **SELECT** key will toggle the display between the log entry (**ERROR**), the odometer reading (**STRIDES**) when the error occurred and the hour meter (**HOURS**) when the error occurred.

16. Pressing and holding the **QUICK START** key for 2 seconds will cause the prompt **CLEAR?** to be displayed, holding the **QUICK START** for an additional 2 seconds will clear all existing entries from the error log. The display will confirm that the error log has been cleared by displaying **OK**. The display will revert to the first log entry and show it as a null entry (**1: ---**). If the **QUICK START** key is not held for a minimum of 4 seconds, the error log will not be cleared.
17. Press the **ENTER** or **RESET** key to exit the information display program.

Procedure 2.3 - Accessing the Set User Parameters Display

Selecting United States standard units causes information to be displayed in miles. Information is displayed in kilometers if metric units are selected. After you select a measurement standard, the software accumulates and records workout information in the units of the measurement standard selected.

Procedure

1. Plug the power cord into the wall outlet, then turn on the EFX 5.21i with the on/off switch.
2. With the **PRECOR EFX 5.21i** banner displayed, press keys **RESET,5,6,7,1**, sequentially.
3. The display name "**SELECT UNITS**" will be displayed for 2 seconds.
4. One of two measurement standards will be displayed, **U. S. Standard** or **Metric**.
5. If **U. S. Standard** is selected, weights will be in pounds and distances will be in miles. If **Metric** is selected, weights will be in kilograms and distances in kilometers.
6. Pressing any arrow key will toggle the units of measure between **US Standard** and **Metric**.
7. Press the **ENTER** key to save the currently displayed selection and exit the set user parameters display or press the **RESET** key to leave the selection unchanged and exit the set user parameters display.

Procedure 2.4 - Documenting Software Problems

When a problem is found with either the software or upper or lower PCA's, record the information listed below. If you isolated the problem to either the PROM, upper PCA, or lower PCA, include the information you have recorded with the malfunctioning PROM or PCA when you ship it to Precor.

When a problem occurs, record the following information:

- Model and serial number
- Software version numbers for upper and lower PCA's

Note:

Look at the PROM mounted on the upper PCA. A label on the PROM indicates the software version number. The part number of the PROM indicates the version number.

- User and program number running when the problem occurred
- A description of:
 - a. What happened or failed to happen.
 - b. The action taken by the user just before the problem occurred.
 - c. Problem-related information (such as how far into the program the problem occurred, the work level being used when the problem occurred, etc.).
- The frequency of occurrence.

Section Three - Preventive Maintenance

Preventive maintenance measures are either scheduled or unscheduled. Scheduled preventive maintenance activities are included here so that you are aware of the preventive measures to be performed on a regular basis.

Regular Preventive Maintenance (Owner)

Cleanliness of the EFX 5.21i and its operating environment will keep maintenance problems and service calls to a minimum. Precor recommends that you perform the following preventive maintenance schedule.

At the End of Each Day

Wipe down the stairarms, ramps, wheels and frame with a damp cloth.

Every Week

Wipe the surface of the electronic console with a slightly-damp sponge or soft cloth. Dry with a clean towel.

CAUTION

Keep water away from electronic components to prevent shock.

On-Site Preventive Maintenance (Service Technician)

Perform the following preventive maintenance tasks each time you are called to service a EFX 5.21i:

Examine the belts for wear, cracks or other signs of deterioration and replace if necessary.

Check the LED's mounted on the upper PCA and the function keys displayed on the electronic console by performing Procedure 2.1.

Visually examine all wires and check connectors and wire connections. Secure connections and replace wiring as necessary.

Section Four - Checking EFX 5.21i Operation

This section provides you with a quick method of checking EFX operation. Check the operation of the EFX at the end of most maintenance procedures.

Procedure

1. Plug the power cord into the wall outlet and set the on/off switch in the “on” position.
2. With the **PRECOR EFX 5.21i** banner displayed, press **QUICK START**.
3. Select Resistance Level 1.
4. Operate the EFX for 4–5 minutes. As you operate the EFX, concentrate on the operating sounds made by the unit. Be on the alert for unusual rubbing, hitting, grinding, or squeaking noises.
5. If the EFX makes unusual noises or the electronic display does not change appropriately, troubleshoot per section 6.
6. Press the **RESISTANCE** ▾ key until you reach Resistance Level 10. Operate the EFX for another 2–3 minutes.
7. If the EFX resistance does not change or the operation of the EFX feels inconsistent compared with Resistance Level 1, troubleshoot per section 6.
8. Press the **RESISTANCE** ▾ key until you reach Resistance Level 20. Operate the EFX for another 2–3 minutes.
9. If the resistance of the EFX 5.21i does not change or the EFX operation feels inconsistent with Resistance Levels 1 and 10, troubleshoot per Procedure 6.5.
10. Check the LED's mounted on the upper PCA and the function keys displayed on the electronic console by performing Procedure 2.1.
11. Turn off the EFX with the circuit breaker, then unplug the power cord from the wall outlet.

Procedure 5.1 - Measuring the Resistance of an Eddy Current Magnet

Caution

Remove power from the EFX before you measure magnet resistance.

Procedure

1. Set the on/off switch in the "off" position, then unplug the power cord from the wall outlet.

WARNING

Before continuing with this procedure, review the Warning and Caution statements listed in Section One, Things You Should Know.

1. Remove the rear cover as described in Procedure 7.1.
2. Set the ohmmeter to a range that will conveniently read up to 125 Ω .
3. Disconnect the magnet wires from the magnet using the quick disconnects shown in the Diagram 5.1 or Diagram 5.2, below. Measure the resistance between the two magnet wires.

Diagram 5.1 - Eddy Current Magnet (serial codes F8 and SS)

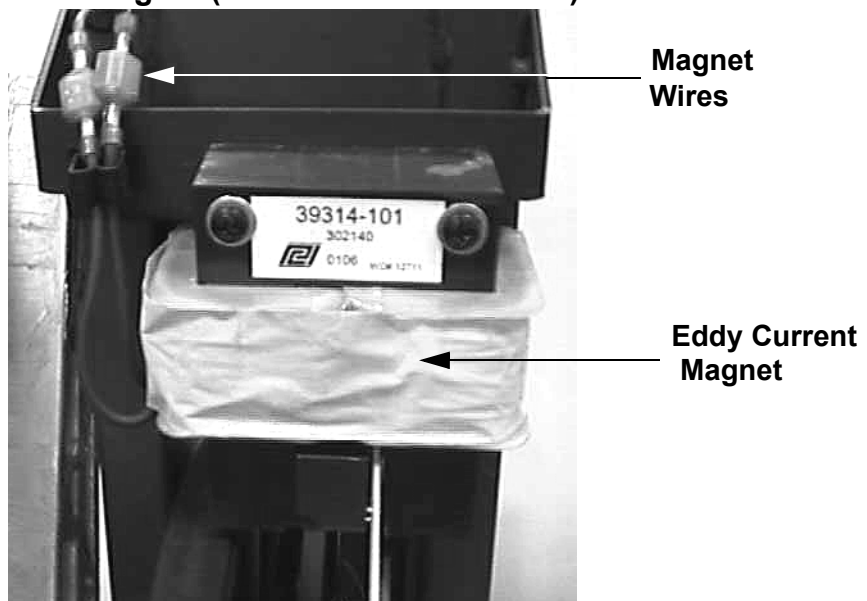

Note:

The resistance of the magnets will be higher than optimum (90 - 110 Ω) when they are warm.

Diagram 5.2 - Eddy Current Magnet (serial code A998)



4. If the resistance measures significantly less than 90Ω or significantly more than 110Ω .

THEN...

Replace the magnet as described in Procedure 7.13.

OTHERWISE...

Reconnect the magnet wires, then continue with the next step.

5. Re-install the rear cover as described in Procedure 7.1, then check the operation of the unit as described in Section Four.
6. Set the on/off switch in the "on" position. Thoroughly test all lift related functions per Section Four.
7. Set the on/off switch in the "off" position, replace the front cover per Procedure 7.1.

Procedure 5.2 - Inspecting and Adjusting Belt Alignment and Tension

Procedure

1. Set the on/off switch in the "off" position, remove the A.C. line cord from the A.C. outlet.

WARNING

Before continuing with this procedure, review the Warning and Caution statements listed in Section One, Things You Should Know.

2. Remove the rear cover as described in Procedure 7.1.
3. Remove both stairarms as described in Procedure 7.17.
4. Operate the unit by rapidly rotating a crankarm by hand. As the unit operates watch the drive belts for proper alignment. The belts should operate parallel to each other and the belts should maintain even spacing.
5. If the belts are not correctly aligned...

THEN...

Continue with the next step.

OTHERWISE...

Skip to step 13

6. Refer to Diagram 5.3 for the following belt alignment steps. The right and left step up belt tension bolts have locking tabs. If necessary, use pliers to bend the locking tabs out of the way so that the bolts can be turned.
7. If the step up pulley belt is out of alignment to the right, continue with step 9.
8. If the step up pulley belt is out of alignment to the left, continue with step 11.
9. Turn the left step up belt tension bolt 1/4 turn clockwise, then repeat step 4. If turning the left adjustment bolt 1/4 of a turn was not sufficient, turn the right step up belt tension bolt 1/4 of a turn counterclockwise.
10. Repeat step 8, alternating between the left and right step up belt tension bolts until the alignment is correct. Continue with step 13.
11. Turn the right step up belt tension bolt 1/4 of a turn clockwise, then repeat step 4. If turning the right step up belt tension bolt 1/4 of a turn was not sufficient, turn the left step up belt tension bolt 1/4 turn counterclockwise.
12. Repeat step 11, alternating between the right and left step up belt tension bolts until the alignment is correct.

13. Belt tension must now be checked and if necessary corrected. Remember, if it is necessary to change belt tension, the belt alignment must be maintained.

Diagram 5.3 - Drive Unit

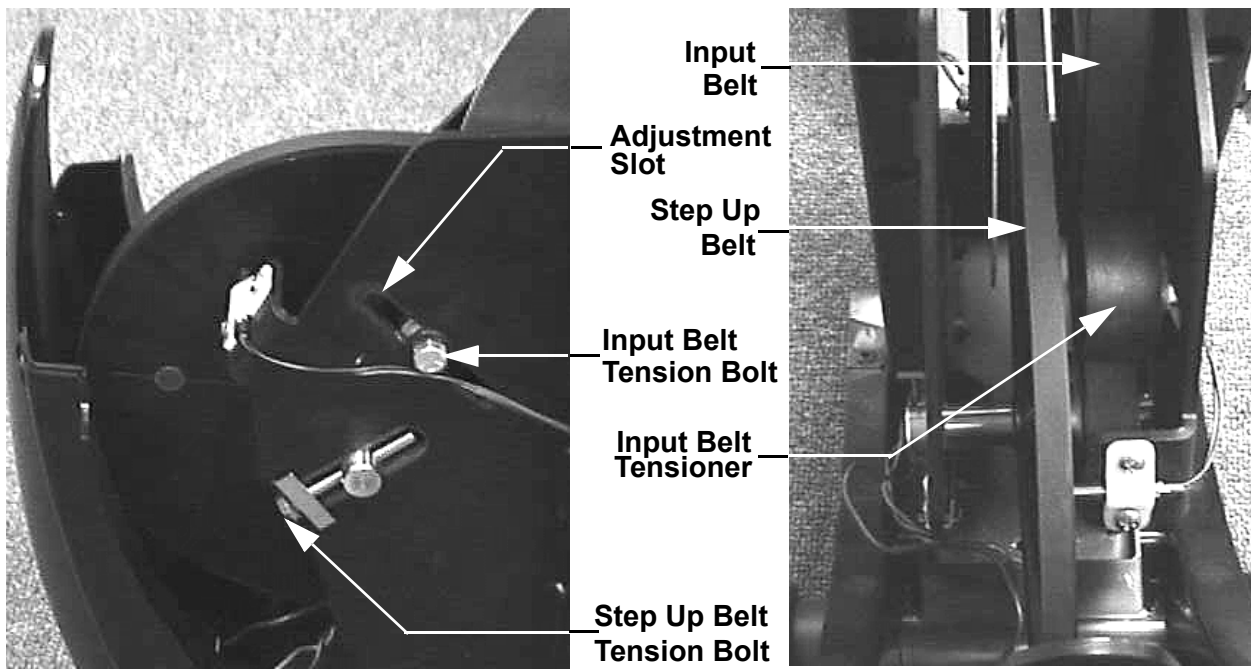

14. Place a belt gauge (McMaster-Carr 6160K12 or Grainger 3HX33) in the middle of the step up belt at the center of the belt span (see Diagram 5.4). Lay a straight edge along the length of the belt and beside the belt gauge. Slide one of the o-rings up against the shoulder of the belt gauge. Press downward on the belt gauge, causing the belt to deflect. Read the deflection on the belt gauge at the edge of the straight edge. Deflect the belt 1/4". Read the tension across the top edge of the o-ring. If the belt is correctly tensioned the gauge will read between 14 and 16 pounds.
15. If the tension in step 14 is correct skip to step 18. Otherwise continue with the next step.

Diagram 5.4 - Measuring Belt Tension

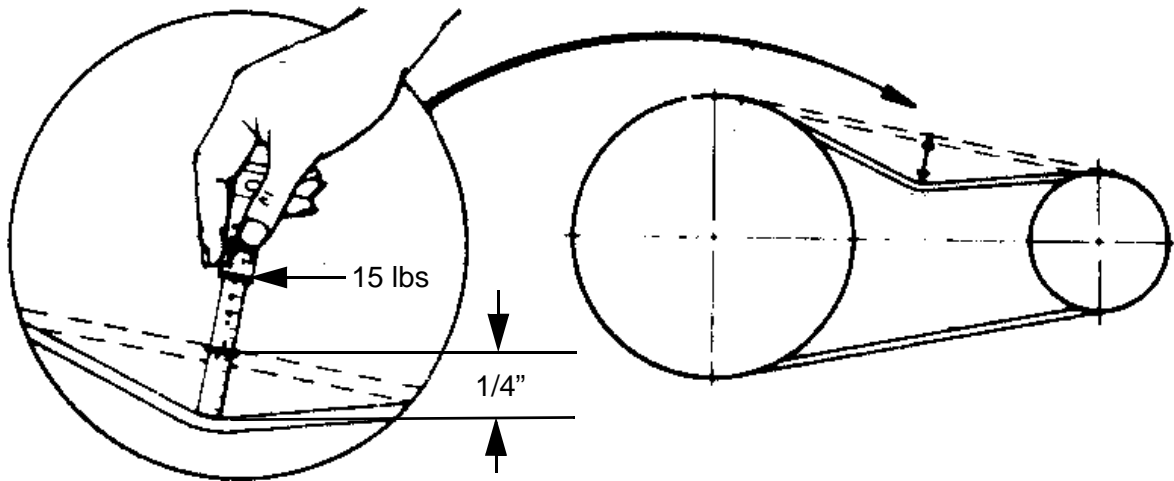

16. If the locking tabs on the right and left step up belt tension bolts have not been straightened, use pliers to bend the locking tabs out of the way so that the bolts can be turned.

IF...

The belt tensioning gauge reads less than 14 pounds

The belt tensioning gauge reads more than 16 pounds

THEN...

Turn both tension bolts **clockwise**, in equal quarter-turn increments, until the belt tensioning gauge reads 14 - 16 pounds @ 1/4" deflection.

Turn both tension bolts **counterclockwise**, in equal quarter-turn increments, until the belt tensioning gauge reads 14 - 16 pounds @ 1/4" deflection.

17. Verify that the belt alignment is still correct by performing the procedure in step 4.
18. When both the step pulley belt tension and alignment are correct, use pliers to bend the tension bolt locking tabs into the "locking" position.
19. The input pulley tension must now be checked and corrected, if necessary. There is not sufficient room to use the belt tension gauge to set the input pulley belt tension. It will be necessary to use the correctly tensioned step up belt as a comparison to set the input belt tension.
20. Using your finger, press in on the center of the step up pulley belt to get a feeling of how much pressure it takes to deflect the belt a 1/4".

21. Using your finger, press in on the center of the lower span of the input belt. Compare the pressure required to deflect the input belt to the pressure required to deflect the step up belt.
22. Loosen the input belt tensioner axle bolt slightly. Slide a stout screwdriver blade into the adjustment slot (See Diagram 5.3) to the left of the pulley. Using the screwdriver as a lever, press the pulley to the right. While maintaining constant pressure on pulley, check the belt tension with your finger. When the belt tension feels correct, tighten and torque the input belt tension bolt to 200 in./lbs.
23. Check the input drive adjustment per Procedure 5.4.
24. Replace the stairarms per Procedure 7.17.
25. Check the operation of the unit as described in Section Four, then re-install the rear cover as described in Procedure 7.1

Procedure 5.3 - Calibrating the Lift Motor

1. In order to calibrate the lift motor, it is necessary to disconnect the lift motor from the ramp assembly.
2. Set the on/off switch in the “off” position. Remove the front cover per Procedure 7.1.
3. Remove the four screws that retain the lift yoke to the ramp assembly. Support the lift motor and ramp assembly as you separate the lift yoke from the ramp assembly. Lower the ramp assembly until it is resting on the frame. (See Diagram 5.5)

Diagram 5.5 - Lift Motor Calibration

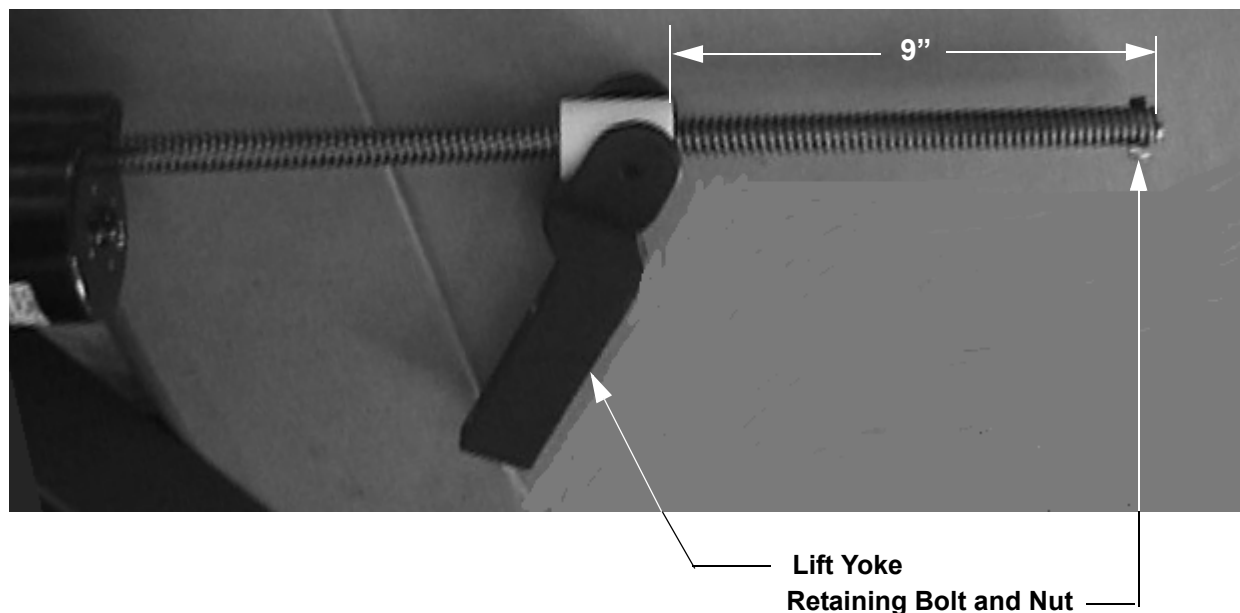

4. Set the on/off switch in the “on” position. Enter the diagnostics routine per Procedure 2.1. After the L.E.D. test is complete, power bits will be displayed. Press the **ENTER** key to display the lift calibration number.
5. Operate the **CROSSRAMP** ▾ or **CROSSRAMP** ◀ keys as required to set the lift calibration number to 127.
6. Rotate the lift yoke on the lift motor drive screw until the distance from the upper surface of the plastic nut in the lift yoke to the end of the drive screw is 9”. If the lift motor drive screw rotates the lift calibration number will no longer be 127. The lift calibration number must be 127 and the distance measurement must be correct for the lift calibration to be correct. See Diagram 5.5.

7. Set the on/off switch in the “off” position. Do not exit the diagnostic program in the normal manner. Exiting the diagnostic program will cause the lift to self center and invalidate the lift calibration just performed.
8. Raise the ramp assembly to a convenient height and slide the lift yoke into the ramp assembly. Hand tighten the four lift yoke mounting screws and then torque them to 240 in/lbs.
9. Set the on/off switch in the “on” position. Thoroughly test all lift related functions per Section Four.
10. Set the on/off switch in the “off” position, replace the front cover per Procedure 7.1.

Procedure 5.4 - Drive Input Assembly Adjustments

This procedure ensures that the drive input assembly, the drive belts and the eddy current magnet are correctly adjusted and aligned. All of the checks described in this procedure must be performed to ensure proper operation.

1. Set the on/off switch in the “off” position, remove the A.C. line cord from the A.C. outlet.

WARNING

Before continuing with this procedure, review the Warning and Caution statements listed in Section One, Things You Should Know.

2. Remove the rear covers as described in Procedure 7.1.
3. Remove both stairarms as described in Procedure 7.17.

Input Drive Assembly Axle Alignment

4. Rotate one of the crankarms to the twelve o'clock position and measure the distance from the crankarm to the frame weldment. See Diagram 5.6. Rotate the opposite crankarm to the twelve o'clock position and measure the distance from the crankarm to the frame weldment. If the two measurements are different by more than 1/16 inch, continue with step 5. If the two measurements are within 1/16 inch, skip to the “input drive axle to step up pulley axle alignment” procedure.

Diagram 5.6 - Crankarm to Frame Weldment Measurements

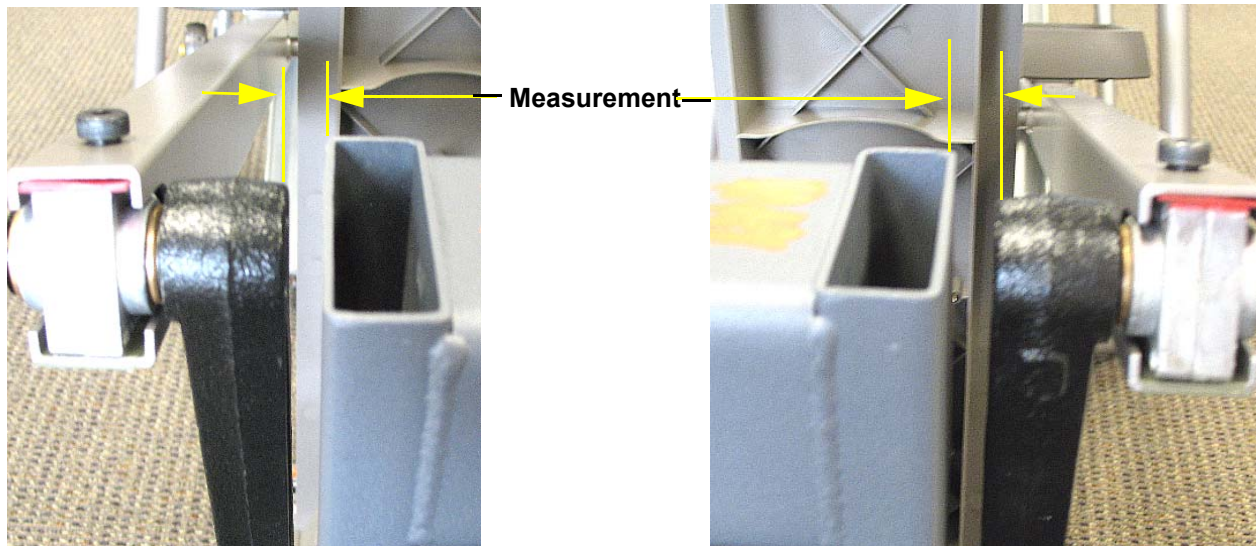

5. On the side with the larger measurement, loosen the upper pillow block mounting nut only, do not loosen the lower pillow block mounting nut. On the side with the smaller measurement, loosen both pillow block mounting nuts. See Diagram 5.6. For purposes of illustration we will assume that the left measurement was larger than the right side measurement in Diagram 5.7.

Diagram 5.7 - Pillow block Mounting Bolts

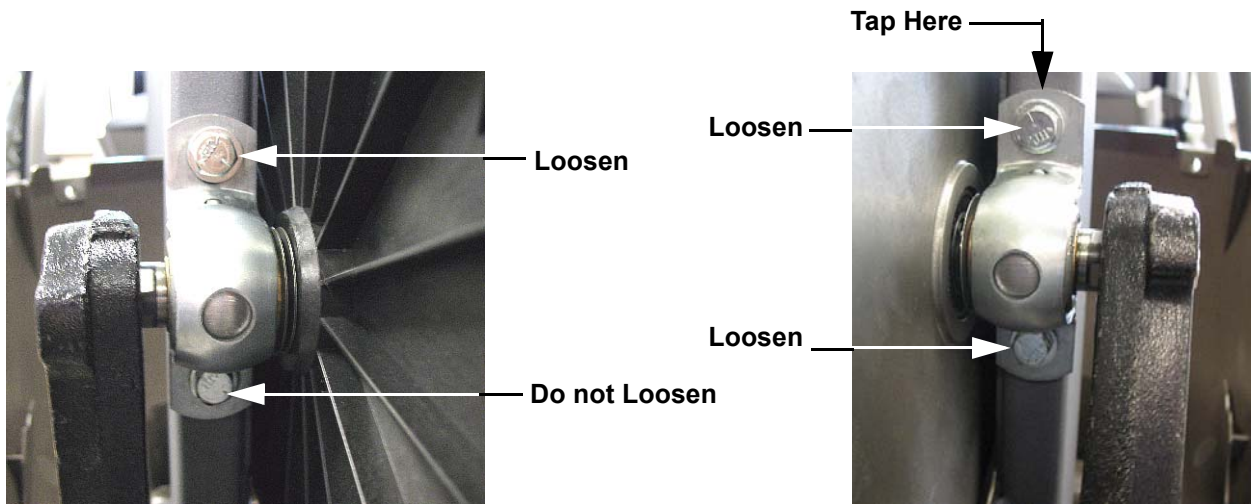

6. Using a rubber mallet, gently tap the top of the pillow block with two loosened nuts (the right hand pillow block in our illustration) until the two measurements in Diagram 5.6 are within 1/16 inch.
7. Torque the three loose pillow block mounting nuts to 80 inch pounds.

Input Drive Axle to Step Up Pulley Axle Alignment

8. Mark the current position of the step up pulley on both side of the drive weldment.
9. On both sides of the drive weldment measure the distance from the input drive axle to the step up pulley axle. See Diagram 5.8.

Diagram 5.8 - Axle to Axle Measurement

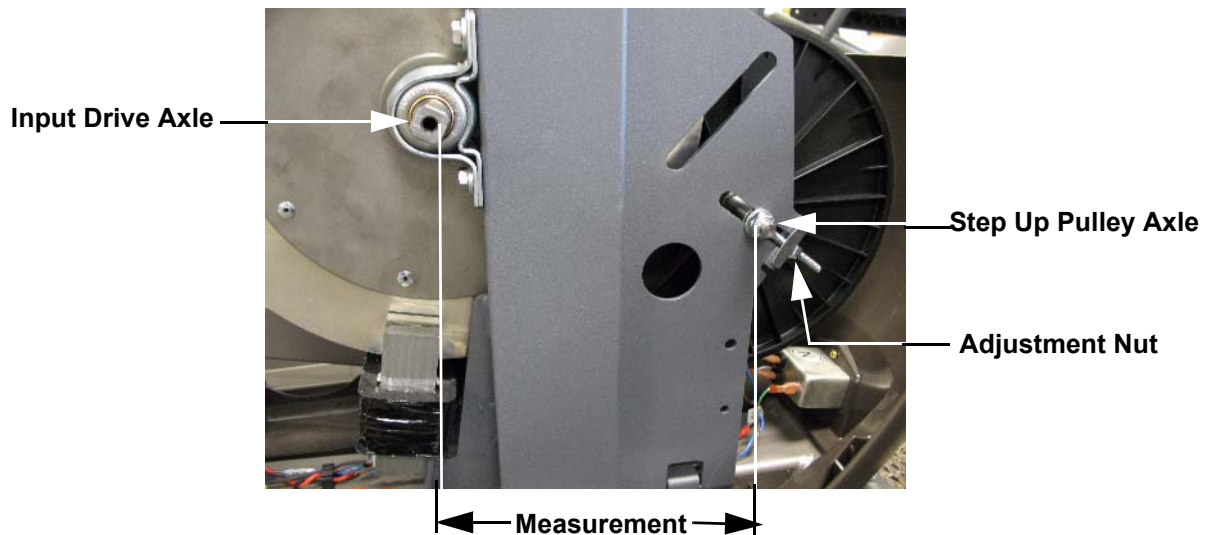

10. If the difference between the two measurements are greater than 1/16 inch, continue with step 11. If the difference is less than 1/16 inch, skip to “eddy current magnet adjustment”.
11. You will be adjusting one half of the difference between the two measurements with each of the step up pulley adjustment nuts.
12. One the side with the smaller measurement, turn the adjustment nut slowly clockwise so that it moves 1/2 of the difference between the two measurements.
13. One the side with the larger measurement, turn the adjustment nut slowly counter-clockwise so that it moves the remaining 1/2 of the difference between the two measurements.
14. Return to step 9 and repeat any necessary steps.

Eddy Current Magnet Adjustment

15. Check the position of the eddy current magnet relative to the eddy current disk The eddy current disk should be centered in the slot in the eddy current magnet. See Diagram 5.9.

Diagram 5.9 - Eddy Current Magnet

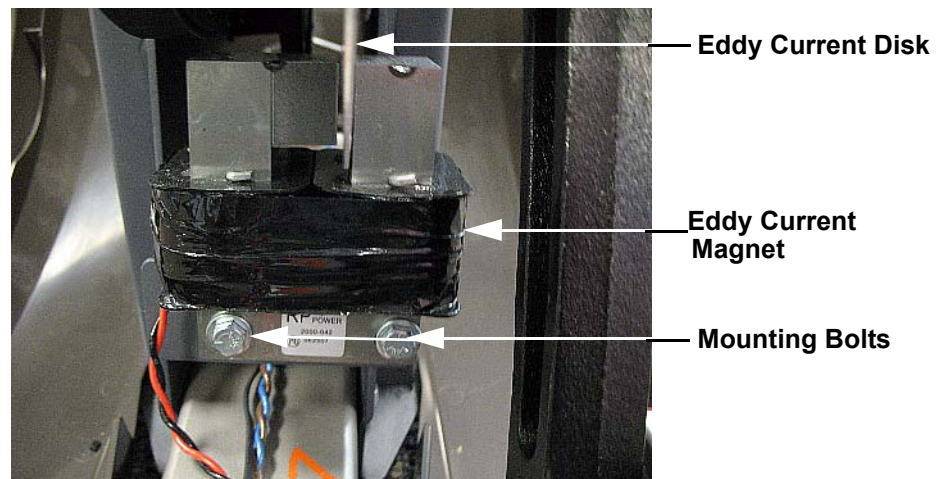

16. If the eddy current disk is not centered, loosen the two eddy current magnet mounting bolts and move the magnet to center the eddy current disk.
17. Tighten and torque the eddy current magnet mounting bolts to 66 inch pounds.

Drive Belt Tracking

18. Stand behind the EFX and sight down the step up pulley drive belt (the narrower belt) to ensure that the belt tracking on the center of the step up pulley. If the belt has run off of one side of the pulley, apply pressure to that side of the belt and slowly rotate the step up pulley to “walk” the belt back onto the step up pulley.
19. Repeat the procedure in step 18 with the primary drive belt (wider belt).
20. Replace both stairarms as described in Procedure 7.17.
21. Replace the rear covers as described in Procedure 7.1.

Procedure 6.1 - Troubleshooting the Lower and Upper Interconnect Cable

Typical symptoms associated with a defective interconnect cable is either an error 30 or no power to the upper PCA. This procedure requires that you have a known good upper interconnect cable, lower interconnect cable and mid-point connector.

1. Set the on/off switch in the off position.
2. If you are troubleshooting an error 30, 31 or 32 continue with step 3, otherwise see Procedure 6.5.
3. Pry the end cap out of the front of the frame base tube (See Diagram 6.1).
4. Carefully withdraw both cables and mid-point connector.

Diagram 6.1 - Interconnect Cables and Mid-Point Connector

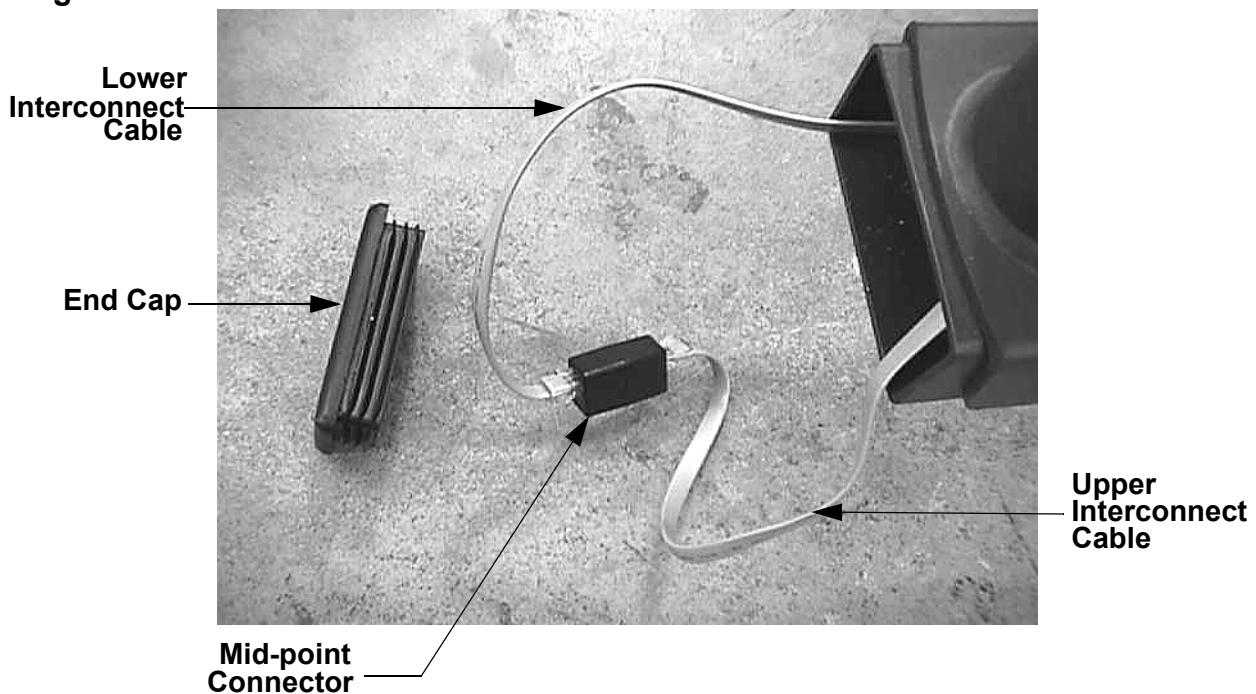

5. Disconnect both cables from the mid-point connector and replace the mid-point connector with a known good mid-point connector. If the mid-point connector does not correct the problem, replace the original mid-point connector and continue with step 5.

6. Remove the rear cover. Disconnect the lower interconnect cable from the lower PCA and the mid-point connector. Substitute a known good interconnect cable from the lower PCA to the mid-point connector. It is not necessary to route the test interconnect cable through the frame tube, for convenience route it externally.
7. If the lower interconnect cable corrects the problem, replace the cable per Procedure 7.4. If the lower interconnect cable does not correct the problem, re-connect the original lower interconnect cable to the lower PCA and mid-point connector and continue with step 7.
8. Remove the upper display housing per Procedure 7.2, steps 1 to 4. Disconnect the upper interconnect cable from the mid-point connector. Substitute a known good interconnect cable from the upper PCA to the mid-point connector. It is not necessary to route the test interconnect cable through the frame tube, for convenience route it externally.
9. If the upper interconnect cable corrects the problem, replace the cable per Procedure 7.4. If the upper interconnect cable does not correct the problem, re-connect the original upper interconnect cable to the mid-point connector and continue with step 9.
10. Replace the upper PCA per Procedure 7.2, steps 9 to 11.
11. If you have performed all of the procedures above and have been unable to correct the problem, call Precor customer service.

Procedure 6.2 - Troubleshooting the Keypad and Upper PCA

If the function keys on the electronic console are unresponsive, the problem may be either the upper PCA or keypad. The keys on this unit are touch sensitive keys. It is necessary to use the keypad diagnostics to troubleshoot the key functions.

Procedure

1. Set the on/off switch in the “off” position.

WARNING

Before continuing with this procedure, review the Warning and Caution statements listed in Section One.

2. If the EFX powers up and functions normally until a particular key(s) is pressed, skip to step 11.
3. If a “error 5 (key depressed)” message is immediately displayed when the EFX is powered up, continue with the next step.
4. This condition may be caused by either the keypad or upper PCA. Set the on/off switch in the “off” position.
5. Remove the four screws that fastens the display housing front panel to the display housing backing plate. These screws are located on the rear of the display housing backing plate.
6. Lift the display housing front panel off of the display housing backing plate. Remove the keypad connector from the upper PCA. See Diagram 6.2.

Diagram 6.2 - Upper PCA & Keypad

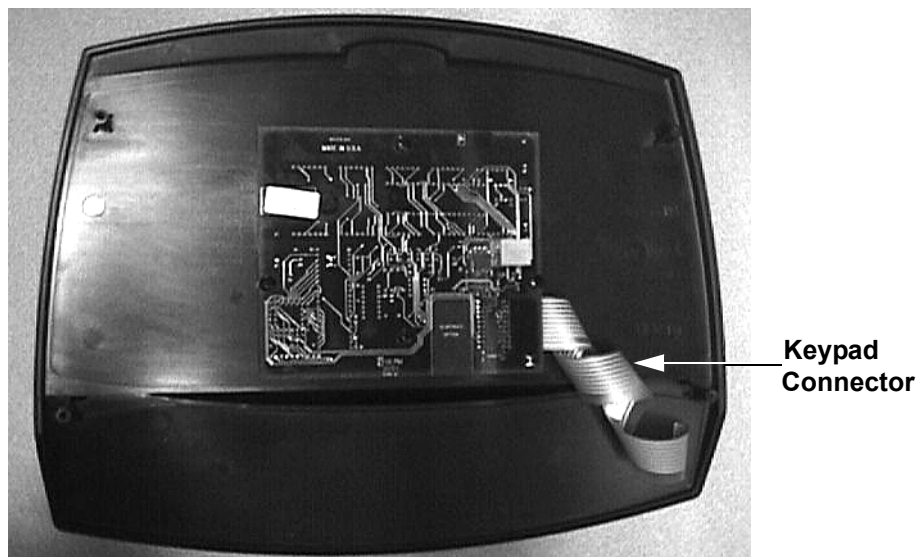

7. Set the on/off switch in the “on” position.
8. If a “error 5 (key depressed)” message is immediately displayed when the EFX is powered up, replace the upper PCA.
9. If a “error 5 (key depressed)” message is not displayed when the EFX is powered up, replace the display housing front panel. The display housing front panel is equipped with the keypad.
10. If you have performed all of the procedures above and have been unable to correct the problem, call Precor customer service.
11. Access the diagnostics program per procedure 2.1. If the key(s) necessary to access the diagnostic program is not functioning, skip to step 14.
12. Test the keypad per Procedure 2.1, step 6.
13. If all of the keys test good, the problem may be user error or a key function that is normally disabled during a particular user program.
14. If one or more keys do not function correctly, either the keypad (display housing) or upper PCA could be defective. Replace the display and repeat step 12. If the display housing did not correct the problem, re-install the original display housing and replace the upper PCA.
15. If you have performed all of the procedures above and have been unable to correct the problem, call Precor customer service.

Procedure 6.3 - Troubleshooting the Speed Sensor

Circuit Description

The speed sensor is a reed switch. A magnet is mounted on the step up pulley. The magnet passes the speed sensor once per revolution. The output from the speed sensor is a 5 Vdc square wave, the frequency of which indicates the operating speed. When a square wave output is not being generated from the speed sensor the system assumes the unit is not in use.

WARNING

Before continuing with this procedure, review the Warning and Caution statements listed in Section One, Things You Should Know.

Procedure

1. Remove the right rear cover section per Procedure 7.1. Set the on/off switch in the “on” position. Operate the unit. If the system timer has not started and a stride rate is not displayed, the speed sensor is not operative. We shall use the presence of a stride rate to determine when the speed sensor is functioning normally.
2. A magnet must be installed in the step up pulley. If the stride rate is not being displayed in step 1, verify that a magnet is installed in the step up pulley and that the space between the end of the reed switch and the step up pulley is approximately 1/8 inch (See Diagram 6.3 for serial codes F8 and SS or Diagram 6.4 for serial code A998).

Diagram 6.3 - Speed Sensor (serial codes F8 and SS)

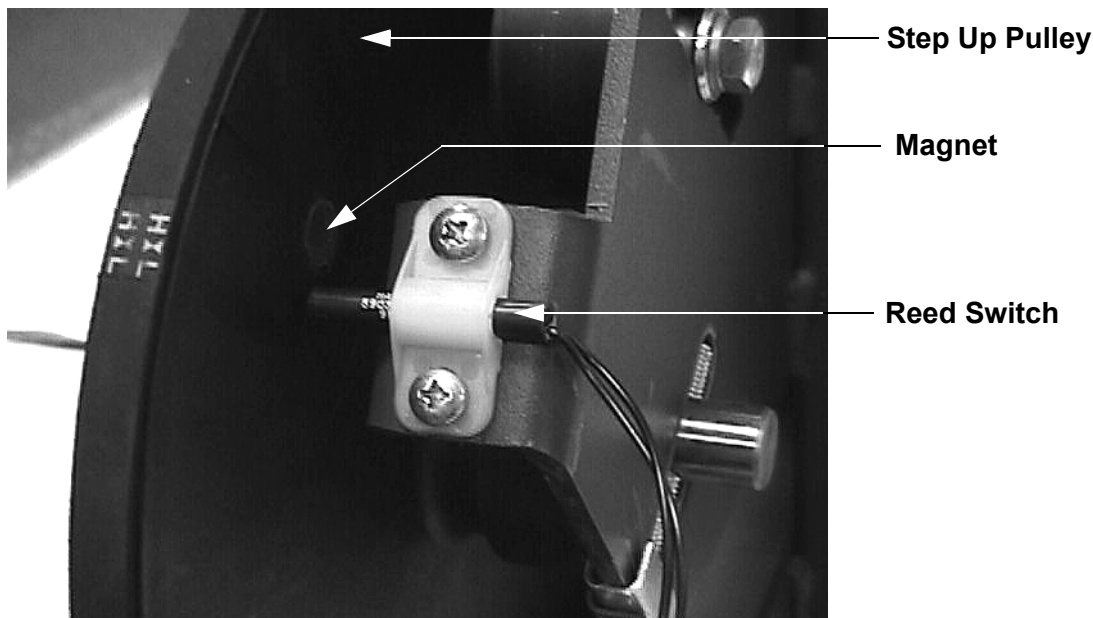
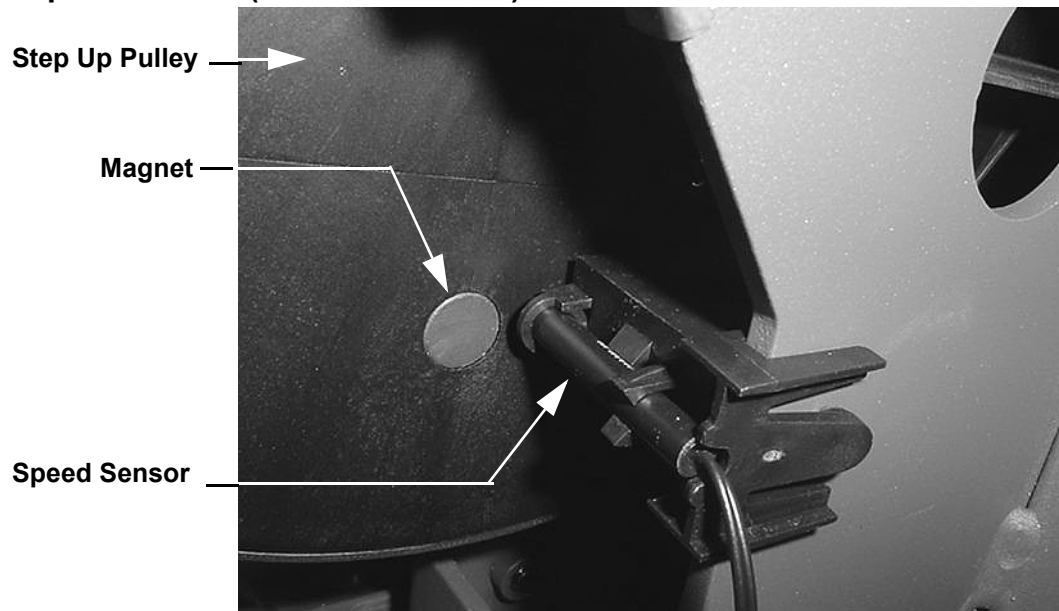

Diagram 6.4 - Speed Sensor (serial code A998)

3. Rotate the step up pulley so that the speed sensor magnet is not near the reed switch. Using a DC voltmeter, measure the voltage between terminal 1 and terminal 5 of J8 on the lower PCA. The measurement should be approximately 5 Vdc. If the measurement is correct, skip to step 4. If the voltage is missing or significantly low, disconnect the speed sensor and repeat the voltage measurement on the J8 connector. If the measurement is now correct (5 Vdc), replace the speed sensor. If the voltage is still missing or significantly low, replace the lower PCA. Skip to step 5.
4. Rotate the step up pulley so that the speed sensor magnet is next to the reed switch. Using a DC voltmeter, measure the voltage between terminal 1 and terminal 5 of J8 on the lower PCA. The measurement should be approximately 0 Vdc. If the voltage is 5 Vdc or significantly high, replace the speed sensor per Procedure 7.12. Skip to step 8.
5. With the an ohmmeter connected to terminals 1 and 5 of J8 on the lower PCA, rock the step up disk forward and backward so that the magnet is passing in front of and away from the reed switch. The ohmmeter should alternate between continuity (very low resistance) and infinity (open circuit). If the resistance measurement does not alternate between continuity and infinity, repeat steps 2 through 4. If the resistance does alternate between continuity and infinity, continue with step 6.
6. If you have performed all of the above tests and the stride rate is not displayed when the unit is operated, there are three parts that could cause the problem. There are not any good tests to check these parts other than substituting a known good part. They are lower PCA, interconnect cable and upper PCA. Replace only one part at a time. If the new part does not correct the problem, replace the original part.
7. If you have performed all of the above tests and the speed sensor is still not functioning, call Precor Technical Support.
8. Check the operation of the EFX as described in Section Four.

Procedure 6.4 - Troubleshooting the Eddy Current System

Note:

If the control circuit does not see an output from the speed sensor, it removes power from the eddy current system. Therefore, when it is necessary to check the resistance or take voltage measurements in the eddy current system it will be necessary to slowly turn the flywheels to ensure that the power time out has not occurred.

WARNING

Before continuing with this procedure, review the Warning and Caution statements listed in Section One, Things You Should Know

1. Remove the rear cover per Procedure 7.1. There are four typical symptoms concerning the eddy current system. No resistance (pedaling resistance), no resistance shortly after power up, incorrect resistance and error 50. If the problem is no resistance, continue with step 2. If the problem is no resistance shortly after power up, test the speed sensor per Procedure 6.3. If the problem is incorrect resistance, skip to step 7. If the problem is an error 50, skip to step 10.
2. Set the on/off switch in the “on” position, enter the manual program and set the resistance at level 10. Using a DC voltmeter, check the voltage across the magnet wires at the lower PCA. The voltage should measure approximately 25 Vdc. If the voltage is missing or significantly low, skip to step 4. If the voltage is correct, continue with step 3.
3. Set the on/off switch in the “off” position. Check the magnet wiring per Diagram 8.1. If any of the magnet wiring is reversed or incorrect the resistance will be affected.
4. Set the on/off switch in the “off” position. Using an ohmmeter, measure between the magnet wires at the lower PCA. The measurement should be approximately 90Ω to 110Ω . If the measurement is open (∞), check the connections at both magnets and the lower PCA and the wires between the lower PCA and the magnets. The lower PCA to magnet wires must read less than 1Ω when measured from end to end with an ohmmeter. Check the EFX per Section Four.
5. If all of the wiring connections are good and there is still no resistance, there are two parts that could cause the problem. There are not any good tests to check these parts other than substituting a known good part. They are lower PCA and upper PCA. Replace only one part at a time. If the new part does not correct the problem re-install the original part.
6. If you have performed all of the above tests and there is still no resistance, call Precor Technical Support.
7. If the resistance is greater than normal, the cause could be mechanical rather than electrical. Set the on/off switch in the off position and test the unit by checking all moving parts in the drive section and stairarms for worn parts that could be “binding”. Replace the appropriate parts.

8. Set the on/off switch in the “on” position, enter the manual program and set the resistance at level 10. Using a DC voltmeter, check the voltage across the magnet wires at the lower PCA. The voltage should measure approximately 25 Vdc.
9. If the voltage is still significantly high or low, there are two parts that could cause the problem. There are not any good tests to check these parts other than substituting a known good part. They are lower PCA and upper PCA. Replace only one part at a time. If the new part does not correct the problem, re-install the original part.
10. Set the on/off switch in the “off” position. Using an ohmmeter, measure between the magnet wires at the lower PCA. The measurement should be approximately 90Ω to 110Ω . If the measurement is significantly low, check the connections at both magnets and the lower PCA.
11. With an ohmmeter, measure between each magnet wire and frame ground. A normal reading for both measurements is open (∞). If the resistance is significantly low, disconnect the J2 connector from the lower PCA and the eddy current magnet.
12. For serial codes F8 and SS, repeat the measurements in step 11, if either measurement is significantly low, replace the lower PCA to eddy current magnet wiring. If both measurements are open (∞), continue with step 13.
13. Measure from both eddy current magnet wires to frame ground. A normal reading for both measurements is open (∞). If the either resistance measurement is significantly low, replace the eddy current magnet.
14. If you have performed all of the above tests and the resistances are still incorrect, call Precor Technical Support.

Procedure 6.5 - Upper Display does not Illuminate

Note:

Serial codes F8 and SS are equipped with two fuses in the A.C. power module and two fuses on the lower PCA. Serial code A998 is equipped with two fuses in the A.C. power module and one fuse on the lower PCA.

Serial codes F8 and SS have two LED's, one green and one red on the lower PCA. Serial code A998 has one green LED on the lower PCA.

1. Set the on/off switch in the "off" position, unplug the line cord from the wall outlet.
2. Remove the F3 system fuse from the lower PCA, serial codes F8 and SS, only. (See Diagram 6.5)
3. Remove the fuses from the power entry module. (See Procedure 7.29)
4. Check all of the fuses with an ohmmeter. They should read approximately 1Ω or less. Replace any fuse that reads significantly high.
5. Replace the fuses in the power input module, do not replace the F3 system fuse at this time (serial codes F8 and SS), at this time.
6. With the line cord still unplugged from the wall outlet, set the on/off switch in the "on" position. Check between the power terminals of the line cord with an ohmmeter. The ohmmeter should read infinity (serial codes F8 and SS) or 1 to 1.5 megohm (serial code A998).
7. If the reading for serial codes F8 and SS is good skip to step 11, if the reading is significantly low, continue with the next step. If the reading for serial code A998 is good, skip to step 13, if the reading is significantly low, continue with the next step
8. If the reading in step 6 is significantly low, check the wiring between the lower PCA and the on/off switch, between the on/off switch and the input module. Replace any cut or nicked wiring.
9. Check the line cord for nicked or cut wiring. Replace the line cord if necessary.
10. For serial codes F8 and SS only, replace the F3 (2 amp) fuse in the lower PCA, if applicable, perform the resistance measurement in step 6. The reading should be approximately 1.1 to 1.5 megohm.
11. If the reading in step 10 (serial codes F8 and SS) or step 6 (serial code A998) is significantly low, replace the lower PCA
12. If you have performed all of the above tests and are unable to resolve the problem, contact Precor customer support.

13. Plug the line cord into the wall outlet and set the on/off switch in the “on” position.
14. Measure between terminals 1 and 8 of the data cable connector on the upper PCA with a DC voltmeter. See Diagram 6.5 or Diagram 6.6. The reading should be approximately 8.3 Vdc.
15. If the reading in step 14 is good, replace the upper PCA. If the reading in step 14 is significantly low, set the on/off switch in the “off” position. Disconnect the data cable from the upper PCA.
16. Set the on/off switch in the “on” position.
17. Measure between terminals 1 and 8 of the data cable connector on the lower PCA with a DC voltmeter. See Diagram 6.5 or Diagram 6.6. The reading should be approximately 8.3 Vdc. if the measurement is good, replace the upper PCA. If the measurement is significantly low, continue with step 18.
18. Disconnect the speed sensor cable from the lower PCA and repeat the measurement in step 17. If the measurement is good, replace the speed sensor. If the measurement is significantly low, replace the interconnect cable.
19. If you have performed all of the above tests and are unable to resolve the problem, contact Precor customer support.

Diagram 6.5 - Lower PCA (Serial codes F8 and SS)

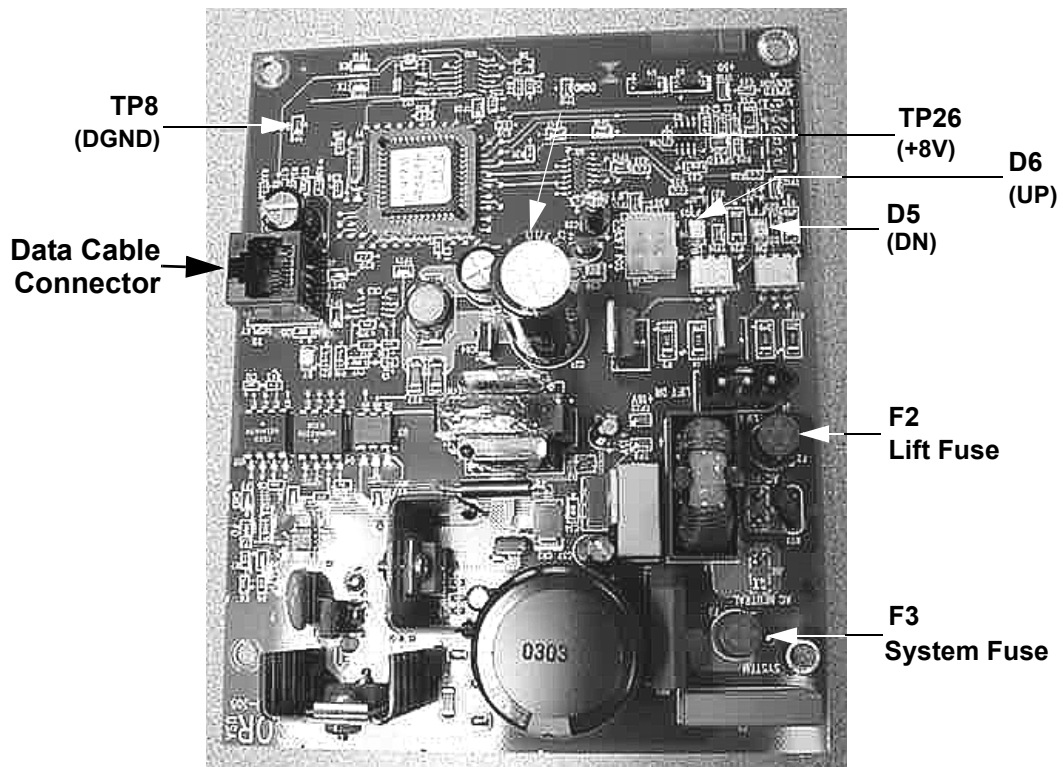
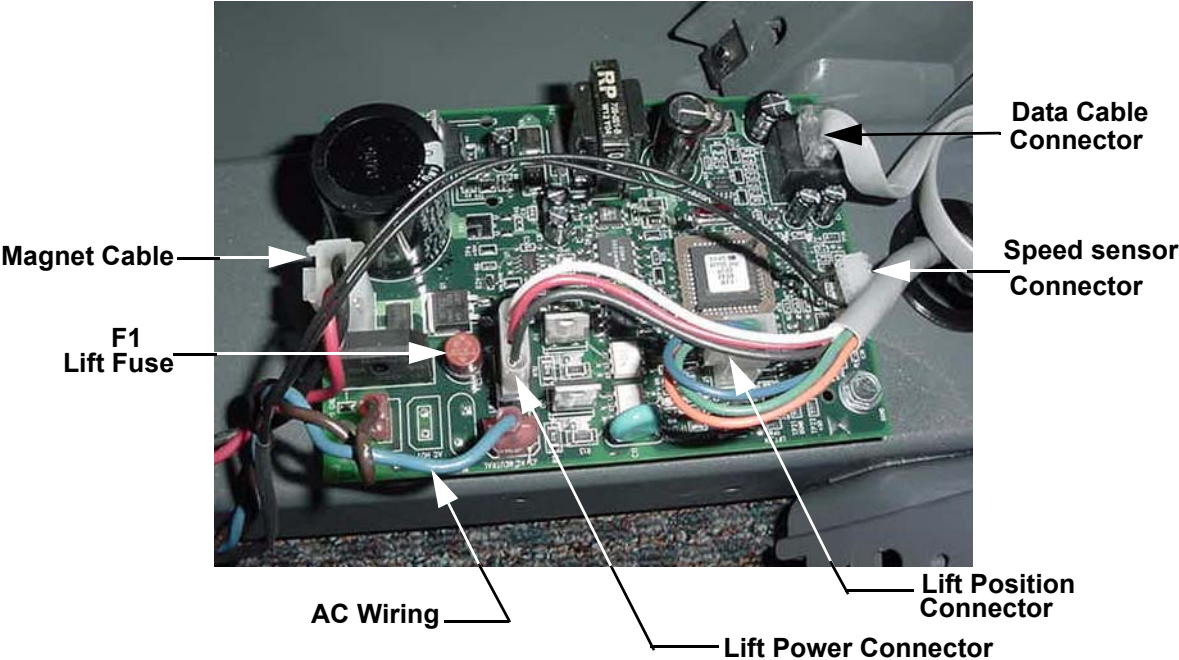

Diagram 6.6 - Lower PCA (Serial code A998)



Procedure 6.6 - Troubleshooting the Lift System

Note:

The lift motor is disabled when the EFX is not being used. The speed sensor must detect motion in order for lift operation to be enabled. In the following procedures, when lift motor movement is being tested the stairarms must be in motion. Before performing this procedure, ensure that the speed sensor is operating normally per Procedure 6.3.

1. If the lift motor will not move skip to step 7. If the lift motor moves and an error occurs continue with step 2.
2. Access the diagnostics program per Procedure 2.1 and proceed to the lift calibration portion of the diagnostics program. If the lift calibration number is 0 or 255 skip to step 3. Operate the lift, if the lift calibration number does not increment as the lift moves, skip to step 3. If the calibration number increments as the lift moves, re-calibrate the lift per Procedure 5.2. If re-calibration does not correct the problem, continue with step 3.
3. Set the on/off switch in the "off" position. Remove the lift position cable connector from the lower PCA. Using an ohmmeter, measure between terminal 1 (brown wire) and terminal 3 (blue wire). The measurement should be approximately 1K Ω . If any of the readings are open (∞) or significantly high, check the lift motor cable and connectors. Repair any wires or connections that are bad. If the cable and connectors are good, replace the lift motor.
4. Using an ohmmeter, measure between terminals 1 and 2 of the lift position connector and measure between 2 and 3 of the lift position connector. The two measurements should total approximately 1K Ω . If any of the readings are open (∞) or significantly high, check the lift motor cable and connectors. Repair any wires or connections that are bad. If the cable and connectors are good, replace the lift motor.
5. If you have performed all of the above tests and an error still occurs when the lift motor operates, there are four parts that could cause the problem. There are not any good tests to check these parts other than substituting a known good part. They are lower PCA, upper interconnect cable, lower interconnect cable and upper PCA. Replace only one part at a time. If the new part does not correct the problem, replace the original part.
6. If you have performed all of the above tests and the lift system is still not functioning, call Precor Technical Support.
7. Set the circuit breaker in the "off" position. Remove the lift fuse (2 amp slow blow) fuse from the lower PCA. Measure the fuse with an ohmmeter. The measurement should be 1 Ω or less. If the fuse is good, re-insert the fuse and skip to step 9. If the fuse is open (∞) or significantly high, replace the fuse. Before operating the lift motor it is necessary to perform a continuity test on the lift motor.

8. Remove the lift power connector from the lower board. Using an ohmmeter, measure between terminals 1 and 2 (white and red) between terminals 1 and 3 (black and white) and between terminals 2 and 3 (red and black). The measurements should be approximately 14.7Ω , 14.3Ω and 29Ω , respectively. If any of the measurements are significantly low, replace the lift motor. If any of the readings are open (∞) or significantly high, check the lift motor cable and connectors. Repair any wires or connections that are bad. If the cable and connectors are good, replace the lift motor.
9. Re-insert the lift power connector in the lower PCA. Set the on/off switch in the "on" position. Using an AC voltmeter, monitor the voltage between terminals 1 and 2 (white and red wires) of the lift power connector. Enter the manual program and press the **CROSSRAMP ▲** key. The measurement should be approximately 120 Vac (line voltage). If the voltage is present and the lift motor moves normally, skip to step 10. The voltage will only be present until such time as an error occurs. If line voltage is not present skip to step 11. If line voltage is measured but the motor does not move, replace the lift motor.
10. Monitor terminals 1 and 3 (white and black wires) of lift power connector. Enter the manual program and press the **CROSSRAMP ▼** key. The measurement should be approximately 120 Vac (line voltage). If the voltage is present and the lift motor moves normally skip to step 13. The voltage will only be present until such time as an error occurs. If line voltage is measured but the motor does not move, replace the lift motor.
11. If the upper display does not indicate that the lift is moving in both directions when the appropriate **CROSSRAMP** key is pressed the problem is either the upper PCA, the keyboard (display housing). Troubleshoot the keyboard per the keyboard portion of Procedure 2.1. If the keyboard is good, replace the upper PCA.
12. If the upper display indicates that the lift is moving in both directions when the appropriate **CROSSRAMP** key is pressed, the problem is either the upper interconnect cable, lower interconnect cable and the lower PCA. There are not any good tests to check these parts other than substituting a known good part. Replace only one part at a time. If the new part does not correct the problem, replace the original part
13. If you have performed all of the above tests and the lift system is still not functioning, call Precor Technical Support.

Procedure 7.1 - Replacing or Removing a Rear Cover Section

Warning: Care must be taken when work is being performed in the area of the stairarms. Pinch points exist between the stairarm and ramp and between the stairarm and crankarm, when the rear covers are removed.

Procedure

1. Set the on/off switch in the “off” position, then unplug the power cord from the A.C. outlet.

WARNING

Before continuing with this procedure, review the Warning and Caution statements listed in Section One, Things You Should Know.

2. The rear cover is a four piece cover; front, top, left and right sections. If the front cover section is being removed, the frame cover must also be removed (See Diagram 7.1).
3. If you are removing either the right or left cover section, it is only necessary to remove the four screws that fasten the cover section.

Diagram 7.1 - Frame Cover

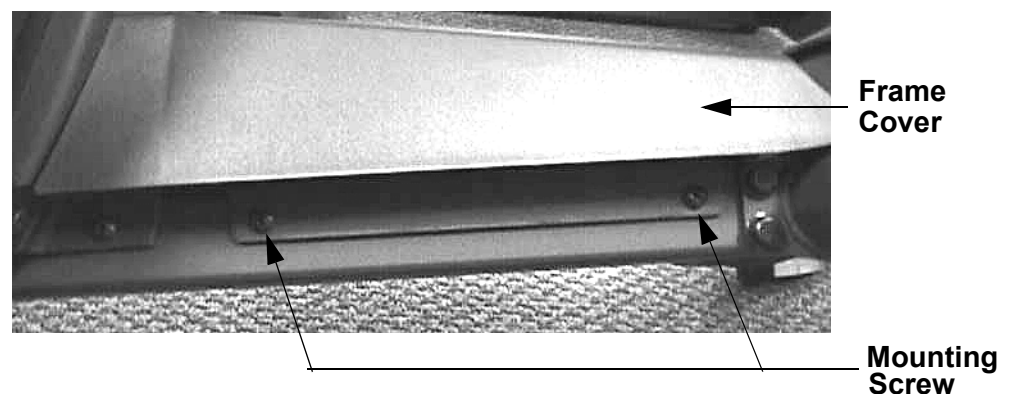

4. If you are replacing either the front or top cover section, you must first remove the left and right cover sections and then remove the cover section being replaced.
5. If you are removing the top cover (See Diagram 7.2), remove the two phillip screws that fasten the top cover section to the frame upright. Remove three screws that fasten the top cover section to the rear cover support. Remove two screws that fasten the top cover section to the front cover section.

6. If you are removing the front cover section, the right, left and top cover sections must be removed first. Remove the four screws that fasten the frame cover to the frame (See Diagram 7.1). Remove two phillips screws that fasten the bottom of the front cover section to the frame. Lift the rear portion of the frame cover and carefully remove the front cover section. If it is necessary to remove the frame cover, lift the rear of the frame cover, slide the frame cover out of the ramp and remove the frame cover.

Diagram 7.2 - Top Cover Section (with right & left cover sections removed)

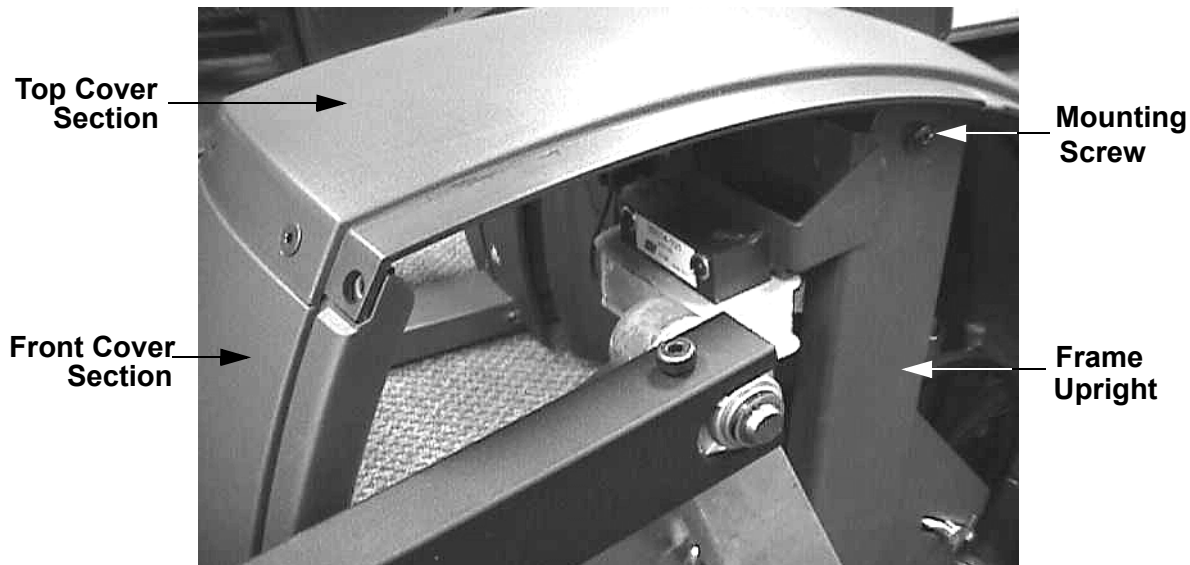

7. If all four cover sections have been removed, first replace the frame cover and front cover section, then the top cover section and then the left and right cover sections as described below.
8. Slide the tongue of the frame cover into the ramp. Lift the rear of the frame cover and fit the front cover against the frame cover. Slide the front and frame covers into place as a unit. Replace and tighten the four phillips screws that fasten the frame cover to the frame. Replace and tighten the two phillips screws that fasten the front cover section to the frame.
9. Set the top cover section in it's mounting position, replace and tighten the two phillips screws that fasten the top cover section to the frame upright. See Diagram 7.2. Replace and tighten the three screws that fasten the top cover section to the rear cover support. Replace and tighten the two screws that fasten the top cover section to the front cover section.
10. Set the left cover section in it's mounting position, replace and tighten the four screws that fasten the left cover section to the front cover section, top cover section and rear cover support.
11. Set the right cover section in it's mounting position, replace and tighten the four screws that fasten the right cover section to the front cover section, top cover section and rear cover support.

Procedure 7.2 - Replacing a Display Enclosure or Upper PCA

Procedure

Anti-static kits (part number 20024-101) can be ordered from Precor.

The keyboard is part of the display housing front panel. If the keyboard is not functioning properly, replace the display housing front panel.

Removing the Display Housing Front Panel

1. Set the on/off switch in the "off" position.

WARNING

Before continuing with this procedure, review the Warning and Caution statements listed in Section One, Things You Should Know.

2. Attach the anti-static wrist strap to your arm, then connect the ground lead of the wrist strap to the units frame.
3. Remove the four screws that secure the display housing front panel to the display backing plate.
4. Disconnect the upper interconnect cable (J1) and the heart rate cable (J2) from the upper PCA.

Removing and Replacing the Upper PCA

5. Carefully disconnect the keyboard cable from the upper PCA (connector J3).
6. Remove the four screws that secure the upper PCA to the display housing front panel.

Note:

Package the upper PCA in an anti-static bag and document the problem as described in Procedure 2.4, Documenting Software Problems.

Diagram 7.3 - Display Housing Front Panel, Rear View

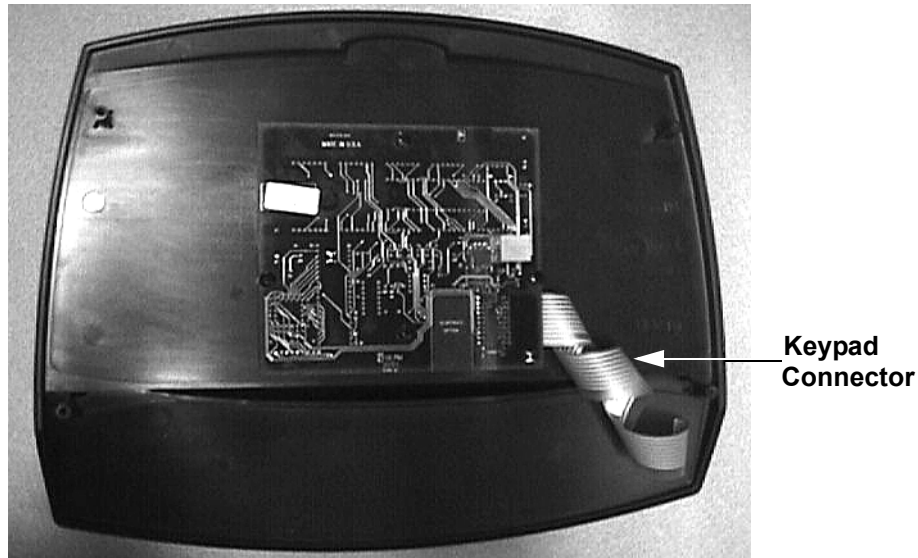

7. Position the replacement upper PCA at its mounting location on the display housing front panel (refer to Diagram 7.3). Replace and tighten the upper PCA mounting screws.
8. Reconnect the keyboard cable to the upper PCA.
9. Reconnect the upper interconnect cable and heart rate cable to the upper PCA.
10. Remove the ground lead of the wrist strap from the EFX frame, then remove the wrist strap from your arm.
11. Position the display enclosure on the display plate. Replace and tighten the display mounting screws.
12. Check operation as described in Section Four.

Procedure 7.3 - Replacing a Lower PCA

Warning: Care must be taken when work is being performed in the area of the stairarms. Pinch points exist between the stairarm and ramp and between the stairarm and crankarm, when the rear covers are removed.

Procedure

1. Set the on/off switch in the “off” position.

WARNING

Before continuing with this procedure, review the Warning and Caution statements listed in Section One, Things You Should Know.

2. Remove the left and right rear cover sections.
3. Attach the wrist strap to your arm, then connect the ground lead of the wrist strap to the EFX frame.
4. For serial code A998, skip to step 11. For serial codes F8 and SS, continue with step 5.
5. Disconnect the magnet, speed sensor and A.C. cables from the lower PCA. See Diagram 7.4. Remove two screws that secure the lower PCA mounting bracket to the frame.

Diagram 7.4 - Lower PCA (serial codes F8 and SS)

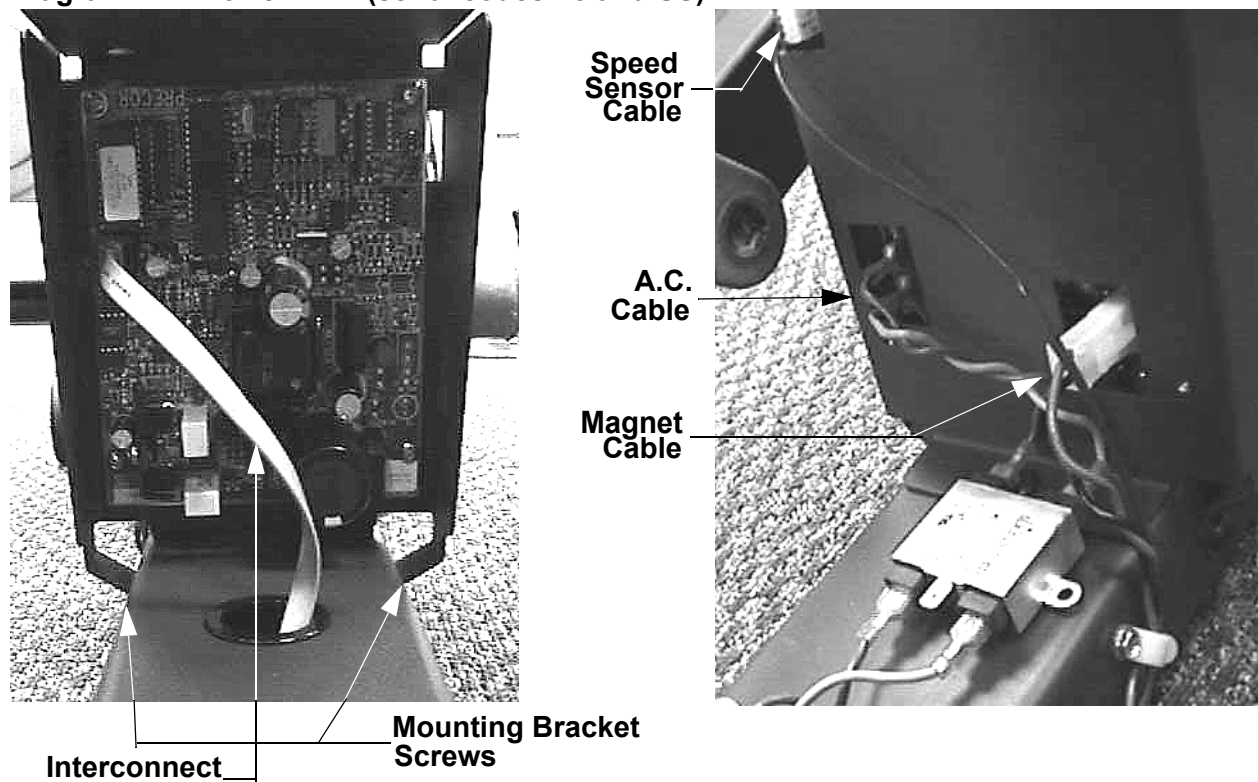

6. Carefully, rotate the lower PCA mounting bracket away from the front cover section and disconnect the interconnect cable from the lower PCA. Remove the lower PCA and mounting bracket from the unit.
7. Remove the four screws that fasten the lower PCA to the mounting bracket and remove the lower PCA from the mounting bracket.
8. Position the replacement lower PCA at its mounting position on the mounting bracket. Fasten the lower PCA to the mounting bracket with the screws removed in step 7.
9. Connect the interconnect cable to the lower and place the lower PCA and mounting bracket in it's mounting position. Fasten the mounting bracket to the frame with the screws removed in step 5.
10. Connect the cables disconnected in Step 4 (See Diagram 7.4).

Diagram 7.5 - Lower PCA (serial code A998))

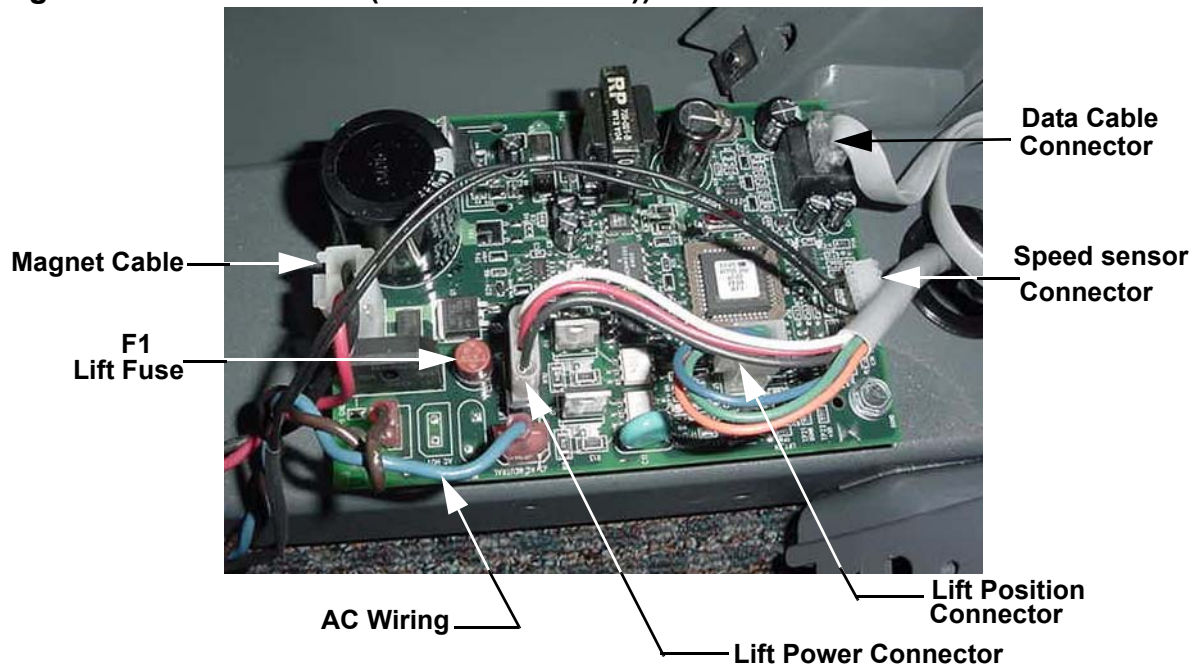

11. Remove the AC wiring, interconnect cable, speed sensor wiring and magnet cable from the lower PCA.
12. Remove the single mounting screw and spacer from the lower PCA. The other three mounting points are plastic “snap on” standoffs. Squeeze the tab on the standoff with a pair of pliers and lift the PCA to remove the PCA from the other three mounting points.
13. Press the replacement lower PCA onto the three plastic standoffs. Place the spacer under the fourth mounting hole and fasten with the screw removed in step 12.
14. Replace the wiring removed in step 11 as shown in Diagram 7.5.

15. Remove the ground lead of the wrist strap from the EFX frame, then remove the wrist strap from your arm.
16. Re-install the left and right rear cover sections per Procedure 7.1. Check the operation of the EFX 5.21i as described in Section Four.

Procedure 7.4 - Replacing a Lower or Upper Interconnect Cable

Procedure

Note: Before you install a new interconnect cable, ensure that the interconnect cable is defective. Refer to Procedure 6.1.

1. Set the on/off switch in the off position.
2. Pry the end cap out the front of the frame base tube with a thin bladed screwdriver (See Diagram 7.6).
3. Carefully withdraw both cables and mid-point connector.

Diagram 7.6 - Interconnect Cables and Mid-Point Connector

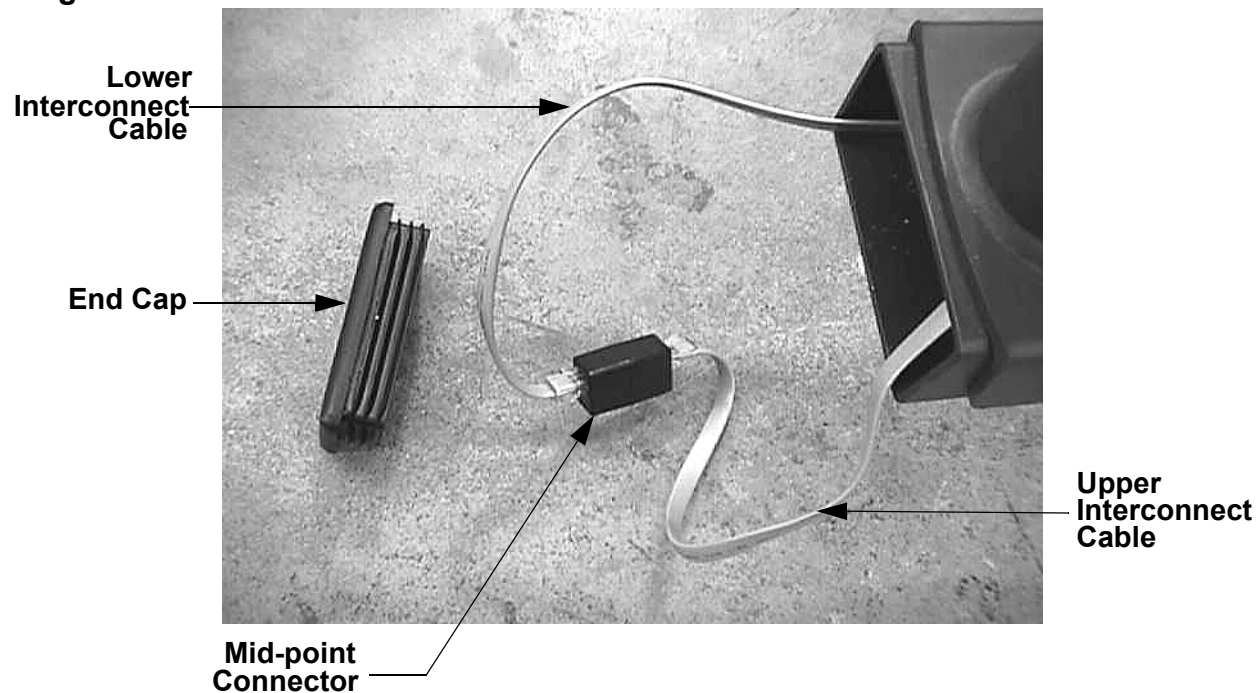

4. If you are replacing the upper interconnect cable skip to step 9. If you are replacing the lower interconnect cable continue with step 5.
5. Remove the left and right rear cover sections. Remove the two screws that fasten the lower PCA mounting bracket to the frame. See Diagram 7.4. Rotate the lower PCA mounting bracket to expose the interconnect cable. Disconnect the interconnect cable from the lower PCA.

6. Securely tape one end of the replacement lower interconnect cable to the lower PCA end of the existing lower interconnect cable. Carefully draw the existing lower interconnect cable out of the front of the frame as you carefully feed the replacement cable into the access hole near the lower PCA.
7. When the replacement interconnect cable emerges from the front of the frame, separate the interconnect cables and discard the defective interconnect cable. Connect the replacement interconnect cable to the lower PCA and mid-point connector. Rotate the lower PCA bracket into its mounting position and fasten it with the screws removed in step 5.
8. Replace the right and left rear cover sections and front frame end cap. Thoroughly, test the unit per Section 4.
9. Remove the display housing per Procedure 7.2, steps 2 to 4. Set the display housing aside. Disconnect the interconnect cable from the upper PCA. See Diagram 7.3. Remove the four screws that fasten the display housing backplate to the main column. Remove the display housing backplate.
10. Securely tape one end of the replacement upper interconnect cable to the upper PCA end of the existing upper interconnect cable. Carefully draw the existing upper interconnect cable out of the front of the frame as you carefully feed the replacement cable into the main column.
11. When the replacement interconnect cable emerges from the front of the frame, separate the interconnect cables and discard the defective interconnect cable. Connect the replacement interconnect cable to the mid-point connector.
12. Feed the interconnect cable through the access hole in the display housing backplate and fasten the display housing backplate to the main column with the screws removed in step 9.
13. Connect the upper interconnect cable to the upper PCA and fasten the display housing to the display housing backplate with the screws removed in step 8.
14. Thoroughly, test the unit per Section 4.

Procedure 7.5 - Replacing a Power Entry Module

Procedure

Note: The power entry module on this EFX is a multifunction unit. It functions as a power entry module, A.C. line fuse holder, on/off switch and A.C. line filter.

1. Set the on/off switch in the off position. Remove the A.C. line cord from the A.C. outlet and from the power entry module.
2. Remove the left and right cover sections per Procedure 7.1.

Diagram 7.7 - Power Entry Module

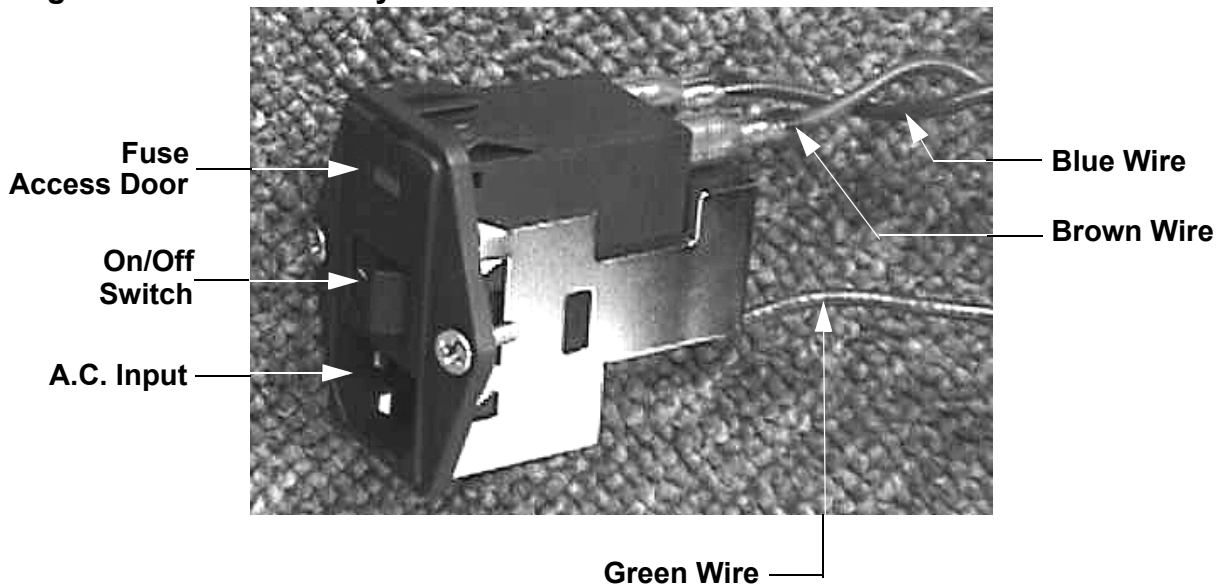

3. Remove the blue wire from terminal D, the brown wire from terminal A and the green wire from the ground terminal of the power entry module.
4. Remove the two screws that fasten the power entry module to the rear cover support. Remove the power entry module from the rear cover support.
5. Open the fuse compartment and remove both fuses (See Procedure 7.25). Check both fuses with an ohmmeter. They should read approximately 1Ω or less. Replace any fuse that reads significantly high.
6. Install the tested fuses, from step 5, in the replacement power entry module.

7. Set the replacement power entry module at its mounting position, secure the power entry module with the screws removed in step 4.
8. Replace the wires removed in step 3. Connect the blue wire to terminal D, the brown wire to terminal A and the green wire to the ground terminal of the power entry module.
9. Replace the left and right cover sections per Procedure 7.1.
10. Insert the A.C. line cord in the power entry module and the A.C. outlet.

Set the on/off switch in the on position and test the EFX per Section Four.

Procedure 7.6 - Replacing a Crankarm Assembly

Warning: Care must be taken when work is being performed in the area of the stairarms. Pinch points exist between the stairarm and ramp and between the stairarm and crankarm, when the rear covers are removed.

Procedure

1. Set the on/off switch in the “off” position, then unplug the power cord from the A.C. outlet.

WARNING

Before continuing with this procedure, review the Warning and Caution statements listed in Section One, Things You Should Know.

2. Remove the left and/or right cover section as described in Procedure 7.1.
3. Remove the left and/or right stairarm assembly as described in Procedure 7.17.

Note:

Notice the position of the two crank arms. When the crankarms are replaced, they must be positioned so that they are 180 degrees opposing.

4. Remove the bolt that secures the crankarm to the input pulley shaft. It will be necessary, use a Pitman arm puller or 4” to 6” gear puller to remove the crankarm. Do not use a hammer or mallet to remove the crankarm.
5. If you are removing both crank arm assemblies, repeat Steps 3 and 4 for the second crankarm assembly.

Diagram 7.8 - Crankarm

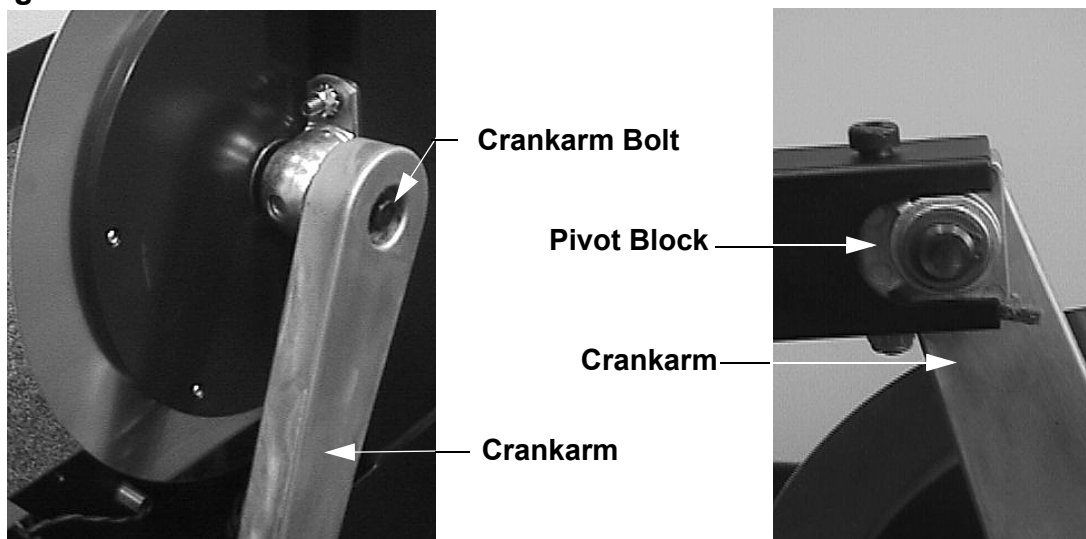

6. Position the crankarm on the input pulley shaft. Thread and hand tighten the 14 mm. bolt into the input pulley shaft. Torque the nut to 300 in/lbs.
7. Position the crankarm on the input pulley shaft. Thread and hand tighten the crankarm mounting bolt into the input pulley shaft. Torque the bolt to 300 in/lbs.
8. Replace the stairarm assembly as described in Procedure 7.17.
9. If you are replacing both crankarm assemblies, repeat steps 8 and 9 for the second crankarm assembly.
10. Set the unit at it's highest resistance setting and use the EFX for a minimum of 3 minutes. Stride in a forward direction for half of the time and in a backward direction for half of the time. Set the on/off switch in the "off" position and re-torque both of the 14 mm. crankarm mounting bolts to 300in/lbs.
11. Replace the left and/or right rear cover per Procedure 7.1.

Procedure 7.7 - Replacing a Pillow Block Bearing

Warning: Care must be taken when work is being performed in the area of the stairarms. Pinch points exist between the stairarm and ramp and between the stairarm and crankarm, when the rear covers are removed.

Procedure

1. Set the on/off switch in the off position, then unplug the power cord from the A.C. outlet.
2. Remove the front, top, left and right cover sections as described in Procedure 7.1.
3. Remove both stairarm assemblies per Procedure 7.17.
4. Remove the crankarm from the same side as the pillow block bearing that you are replacing.
5. Remove the eddy current magnet per Procedure 7.13.
6. Remove tension from the input pulley and step-up pulley belts as described below:
 - a. Loosen the input belt tensioner axle nut and turn the input belt tensioner adjustment bolt counterclockwise until tension is removed from the input belt. (See Diagram 5.4)
 - b. Straighten the locking tabs and turn the left and right tension bolts counterclockwise until tension is removed from the step up belt. (See Diagram 5.4)
 - c. Slide the input and step up belts off of their pulleys.
7. Remove the nuts that secure both pillow block bearings to the mounting studs (serial codes F8 and SS) or mounting bolts (serial code A998) on the drive weldment uprights. (See Diagram 7.9 or Diagram 7.10)
8. Lift the pillow block assembly off of the mounting studs and slide the pillow block assembly off of the input pulley shaft.
9. Slide the replacement bearings onto the input pulley shaft and set the pillow block bearings in their mounting position on the frame studs.

Diagram 7.9 - Pillow Block Bearings (serial codes F8 and SS)

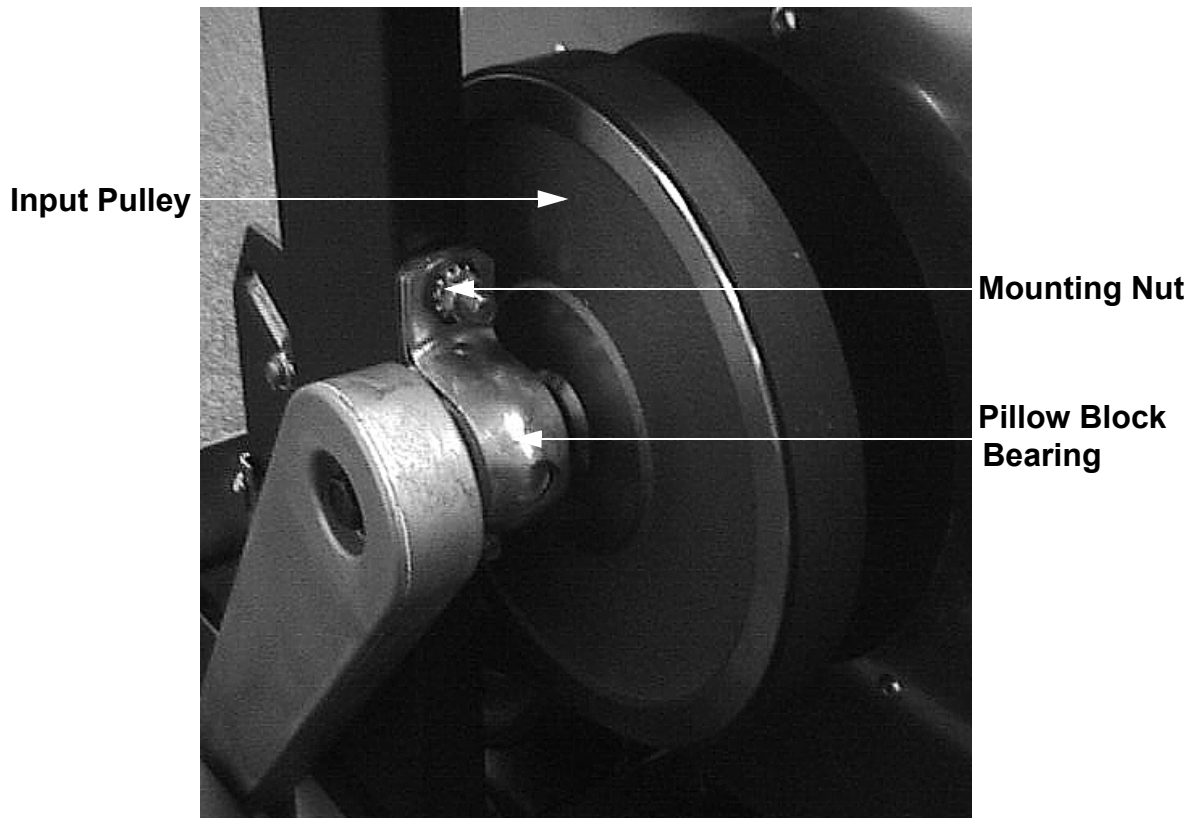

Diagram 7.10 - Pillow Block Bearings (serial code A998)



10. Thread and hand tighten the pillow block mounting nuts onto the mounting studs or mounting bolts. Torque the pillow block mounting nuts to 80 in/lbs.
11. Tighten the right and left hand tension bolts and the input belt tensioner adjustment bolt to remove most of the slack from the belt.

12. Tension the belts per Procedure 5.2.
13. Replace the crankarm(s) per Procedure 7.6.
14. Replace the eddy current magnet per Procedure 7.13.
15. Check the input drive adjustment per Procedure 5.4.
16. Replace the stairarms per Procedure 7.17.
17. Replace the front, top, left and right cover sections per Procedure 7.1.

Procedure 7.8 - Replacing an Input Drive Assembly

Warning: Care must be taken when work is being performed in the area of the stairarms. Pinch points exist between the stairarm and ramp and between the stairarm and crankarm, when the rear covers are removed.

Procedure

Note: The input drive assembly consists of the input pulley assembly and eddy current disk assembly.

1. Set the on/off switch in the “off” position, then unplug the power cord from the wall outlet.

WARNING

Before continuing with this procedure, review the Warning and Caution statements listed in Section One, Things You Should Know.

2. Remove the front, top, left and right cover sections as described in Procedure 7.1.
3. Remove the stairarm assemblies as described in Procedure 7.17.
4. Remove the crankarm assemblies as described in Procedure 7.6.
5. Remove the eddy current magnet per Procedure 7.13.
6. Remove tension from the drive belts and remove the pillow block bearings per Procedure 7.7, steps 6 to 8.
7. Slide the step up and input belts off of the input drive assembly and remove the input drive assembly from the EFX. (See Diagrams 7.11 and 7.12).

Diagram 7.11 - Eddy Current Disk

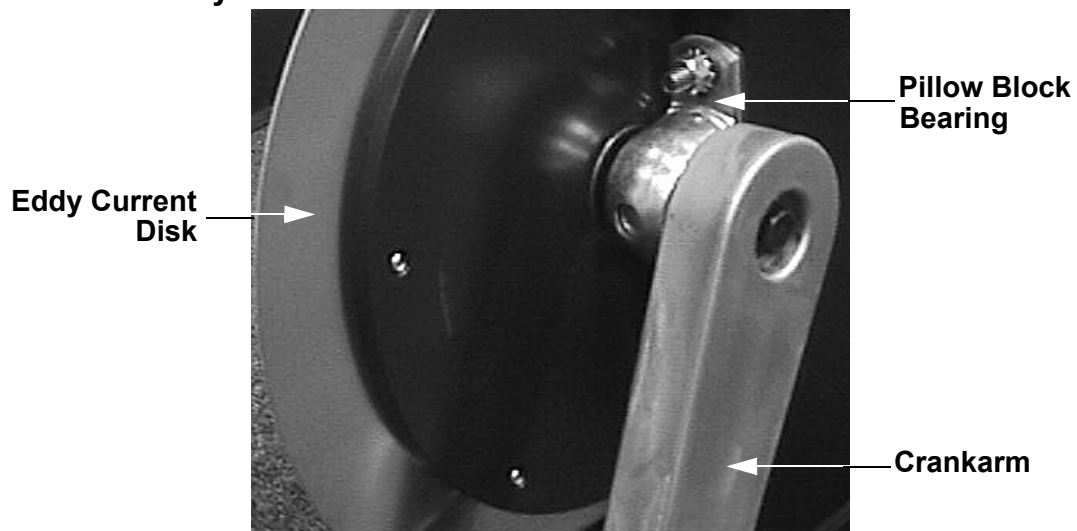

8. Slide the step up and input belts onto the input drive assembly as you set the input drive assembly in it's mounting position in the EFX.
9. Replace the magnet assembly per Procedure 7.13.
10. Complete the installation, alignment and tensioning per Procedure 7.7, steps 9 to 17.

Procedure 7.9 - Replacing an Input Pulley Belt

Warning: Care must be taken when work is being performed in the area of the stairarms. Pinch points exist between the stairarm and ramp and between the stairarm and crankarm, when the rear covers are removed.

1. Procedure

1. Set the on/off switch in the “off” position, then unplug the power cord from the A.C. outlet.

WARNING

Before continuing with this procedure, review the Warning and Caution statements listed in Section One, Things You Should Know.

2. Remove the front, top, left and right cover sections as described in Procedure 7.1.
3. Remove the stairarm assemblies as described in Procedure 7.17.
4. Remove the crankarm assemblies as described in Procedure 7.6.
5. Remove the magnet assembly as described in Procedure 7.13.
6. Remove tension from the drive belts and remove the pillow block bearings per Procedure 7.7, steps 6 to 8.
7. Slide the step up and input belts off of the input drive assembly and remove the input drive assembly from the unit. (See Diagrams 7.10 and 7.11)
8. Remove the four bolts that retain rear cover support and power entry module. Swing the rear cover support away from the drive unit.
9. Remove the left and right tension bolts, locking tabs and brackets. Slide the step up pulley assembly with both the step up and input belts out of the drive unit.
10. Remove the input pulley belt and place the replacement input pulley belt in it's place on the step up pulley assembly.
11. Set the step up pulley assembly with the step up and input belt at its mounting position in the drive unit. Replace the tensioning bolts, locking tabs and brackets removed in step 8. Thread the left and right tension bolts into the step up pulley shaft. (See Diagram 7.12 and Diagram 7.13)

Diagram 7.12 - Input Pulley Belt

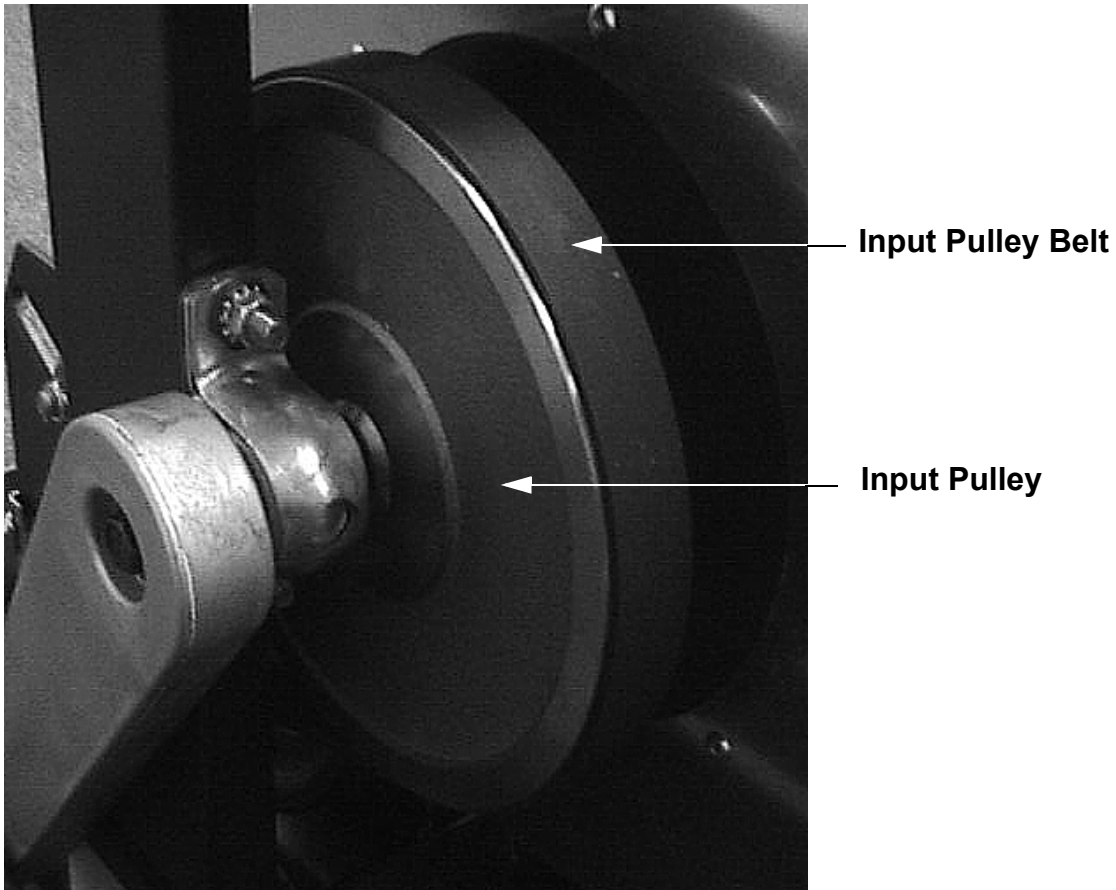

12. Slide the step up and input belts onto the input drive assembly as you set the input drive assembly in its mounting position in the drive unit.
13. Slide the pillow block bearings onto the input pulley shaft.
14. Complete the installation, alignment and tensioning per Procedure 7.7, steps 9 to 17.

Procedure 7.10 - Replacing a Step-Up Pulley Belt

Warning: Care must be taken when work is being performed in the area of the stairarms. Pinch points exist between the stairarm and ramp and between the stairarm and crankarm, when the rear covers are removed.

1. Procedure

1. Set the on/off switch in the “off” position, then unplug the power cord from the wall outlet.

WARNING

Before continuing with this procedure, review the Warning and Caution statements listed in Section One, Things You Should Know.

2. Remove the front, top, left and right cover sections as described in Procedure 7.1.
3. Remove the stairarm assemblies as described in Procedure 7.17.
4. Remove the crankarm assemblies as described in Procedure 7.6.
5. Remove the magnet assembly as described in Procedure 7.13.
6. Remove tension from the drive belts and remove the pillow block bearings per Procedure 7.7, steps 6 to 8.
7. Remove the input drive assembly from the unit. (See Diagrams 7.10 and 7.11)
8. Remove the four bolts that retain rear cover support and power entry module. Swing the rear cover support away from the drive unit.
9. Remove the left and right tension bolts, locking tabs and brackets. Slide the step up pulley assembly with both the step up and input belts out of the drive unit.
10. Remove the step up pulley belt and place the replacement step up pulley belt in its mounting position on the step up pulley assembly.
11. Set the step up pulley assembly with the step up and input belt at its mounting position in the drive unit. Replace the tensioning bolts, locking tabs and brackets removed in step 8. Thread the left and right tension bolts into the step up pulley shaft.
12. Slide the step up and input belts onto the input drive assembly as you set the input drive assembly in its mounting position in the drive unit.

Diagram 7.13 - Step Up Pulley Belt

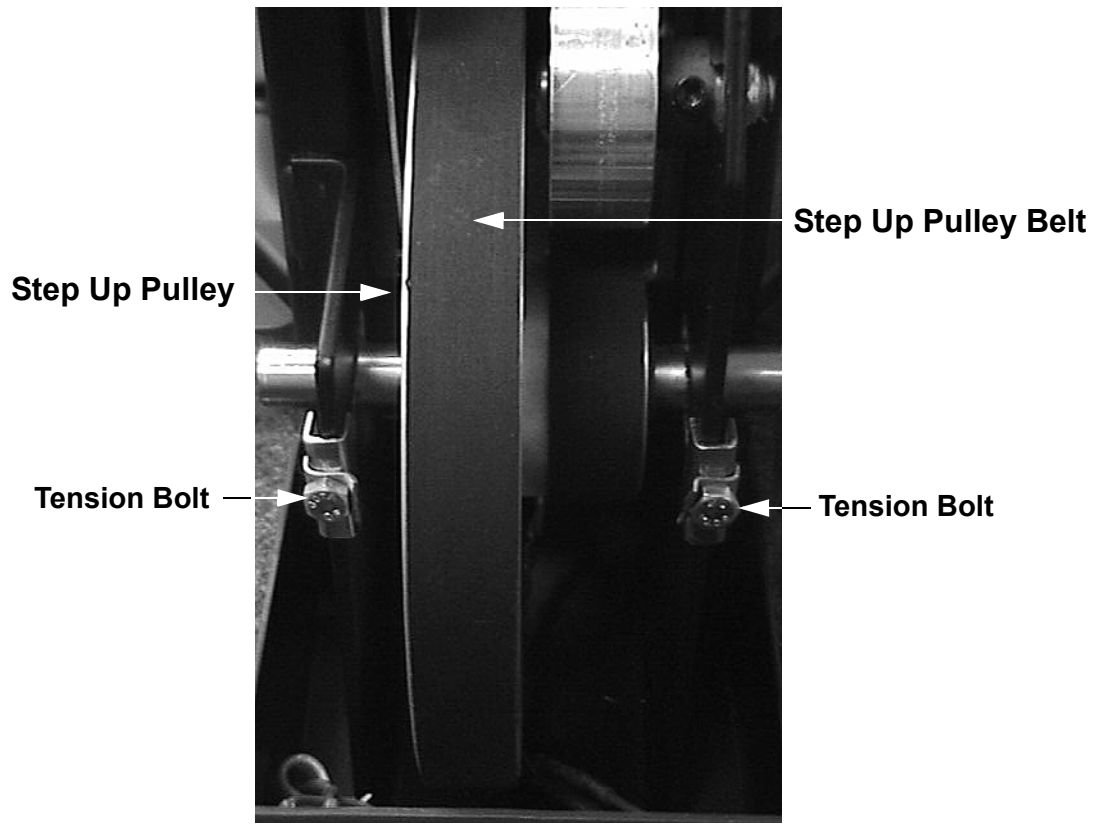

13. Slide the pillow block bearings onto the input pulley shaft.
14. Complete the installation, alignment and tensioning per Procedure 7.7, steps 9 to 16.

Procedure 7.11 - Replacing a Step-Up Pulley Assembly

Warning: Care must be taken when work is being performed in the area of the stairarms. Pinch points exist between the stairarm and ramp and between the stairarm and crankarm, when the rear covers are removed.

1. Procedure

1. Set the on/off switch in the “off” position, then unplug the power cord from the wall outlet.

WARNING

Before continuing with this procedure, review the Warning and Caution statements listed in Section One, Things You Should Know.

2. Remove the front, top, left and right cover sections as described in Procedure 7.1.
3. Remove the stairarm assemblies as described in Procedure 7.17.
4. Remove the crankarm assemblies as described in Procedure 7.6.
5. Remove the magnet assembly as described in Procedure 7.13.
6. Remove tension from the drive belts.
7. Slide the step up and input belts off of their pulleys.
8. Remove the left and right tension bolts, locking tabs and brackets.
9. Carefully, lay the EFX on it's side. Remove the four bolts that retain rear cover support and power entry module. Swing the rear cover support away from the drive unit.
10. Slide the step up pulley assembly with both the step up and input belts out of the drive unit.
11. Place the step up and input belts on the replacement step up pulley assembly.
12. Set the replacement step up pulley assembly with the step up and input belt at it's mounting position in the unit. Replace the tensioning bolts, locking tabs and brackets removed in step 8. Thread the left and right tension bolts into the step up pulley shaft.
13. Slide the step up and input belts onto the input drive assembly as you set the input drive assembly in its mounting position in the unit.
14. Slide the pillow block bearings onto the input pulley shaft.
15. Complete the installation, alignment and tensioning per Procedure 7.7, steps 9 to 17.

Procedure 7.12 - Replacing a Speed Sensor Assembly

Procedure

1. Set the on/off switch in the “off” position.

WARNING

Before continuing with this procedure, review the Warning and Caution statements listed in Section One, Things You Should Know.

2. Remove the left and right cover sections as described in Procedure 7.1.
3. Disconnect the speed sensor cable from the lower PCA. (See Diagram 7.4 or Diagram 7.5).
4. For serial codes F8 and SS, remove the hardware that secures the speed sensor assembly to the drive unit. remove the speed sensor. See Diagram 7.14.
5. For serial code A998, unsnap the speed sensor from the speed sensor clip and remove the speed sensor. See Diagram 6.4.

Diagram 7.14- Speed Sensor (serial codes F8 and SS)

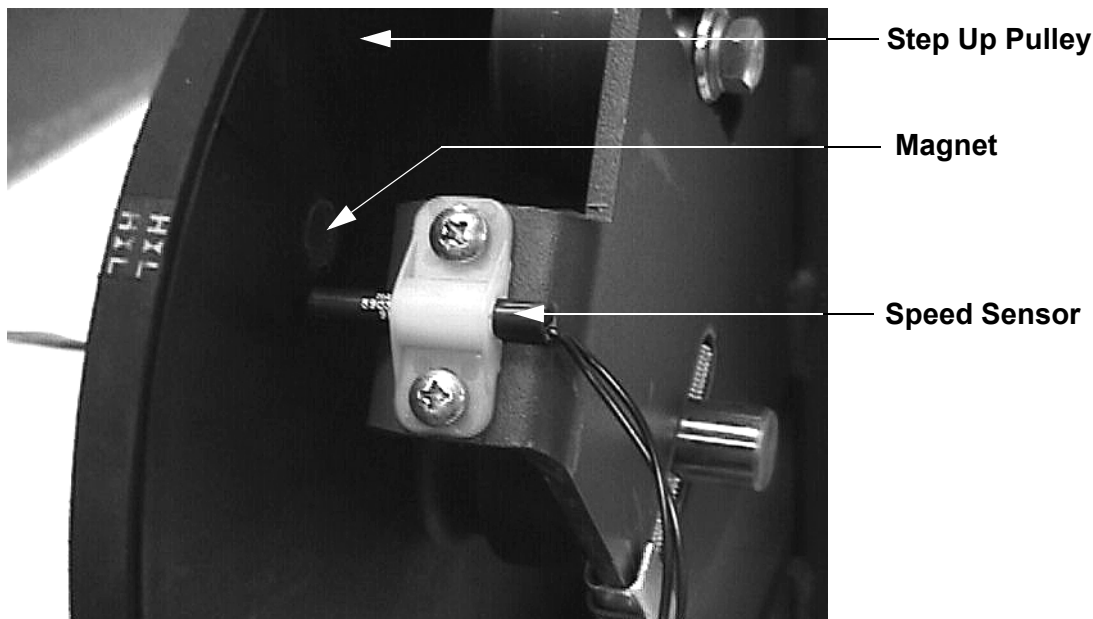

6. For serial codes F8 and SS, position the speed sensor at its mounting position and set the gap between the end of the speed sensor and the step up pulley at approximately 1/8 inch. Replace the hardware that secures the speed sensor to the drive unit. Torque the speed sensor screws to 27 in./lbs.
7. For serial code A998, snap the replacement speed sensor into the speed sensor clip. See Diagram 6.4.

8. Reconnect the speed sensor cable to the lower PCA.
9. Re-install the left and right cover sections as described in Procedure 7.1, then check the operation of the EFX as described in Section Four.

Procedure 7.13 - Replacing an Eddy Current Magnet Assembly

Procedure

1. Set the on/off switch in the “off” position, then unplug the power cord from the wall outlet.

WARNING

Before continuing with this procedure, review the Warning and Caution statements listed in Section One, Things You Should Know.

2. Remove the left and right cover sections as described in Procedure 7.1.
3. For serial code A998, skip to step 10. For serial codes F8 and SS, continue with step 4.
4. Disconnect the magnet cable from the magnet assembly. See Diagram 7.15.
5. Remove the bolts that secure the magnet assembly to the drive unit. Remove the magnet from the drive unit.

Diagram 7.15 - Eddy Current Magnet (Serial codes F8 and SS)

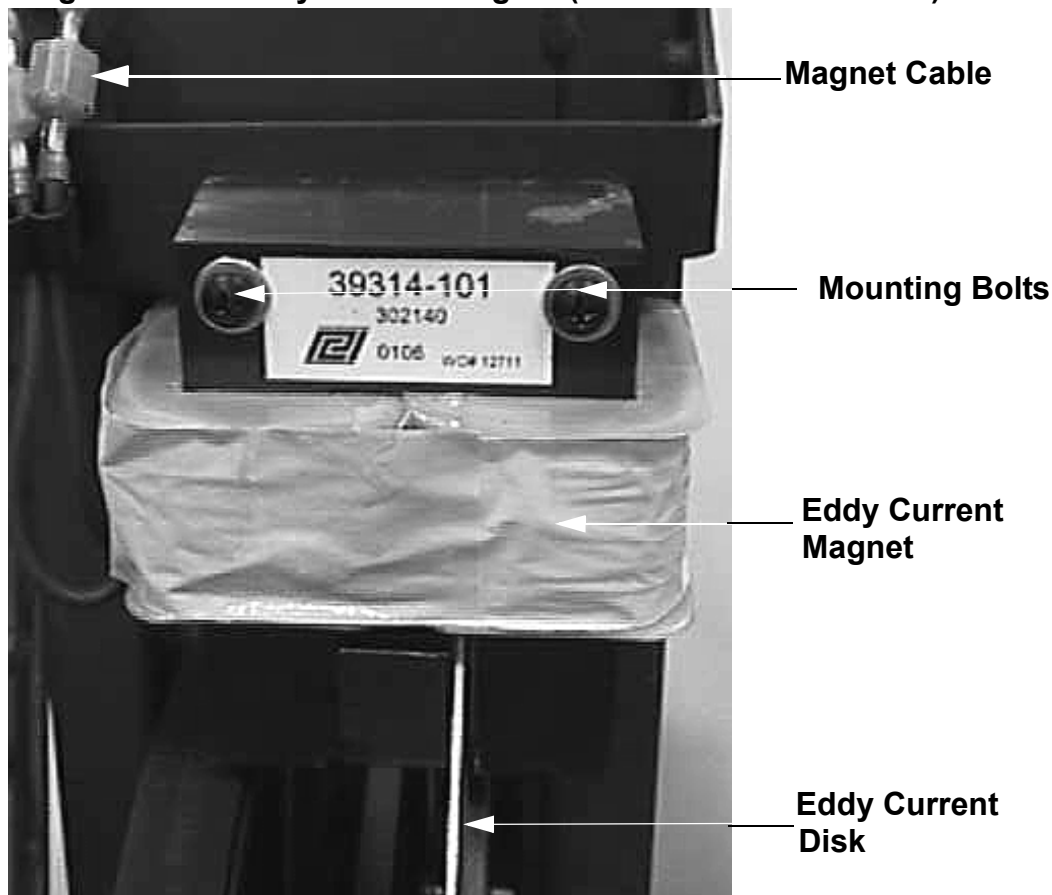

6. Position the magnet assembly at its mounting position so that the eddy current disk is centered between the magnet poles.
7. Replace and hand tighten the magnet assembly mounting bolts. Torque the magnet assembly mounting bolts to 43 in/lbs.
8. Reconnect the magnet cable to the magnet assembly.
9. Re-install the left and right cover sections as described in Procedure 7.1, then check the operation of the EFX as described in Section Four.
10. Disconnect the magnet cable from the lower PCA. See Diagram 6.6.
11. Remove the bolts that fasten the eddy current magnet to its frame mounting. See Diagram 7.16.

Diagram 7.16 - Eddy Current Magnet (serial code A998)



12. Set the replacement eddy current magnet in its mounting position and fasten it with the hardware removed in step 11. Torque the eddy current mounting bolts to 47 inch pounds.
13. Connect the magnet cable to the lower PCA.
14. Check the input drive adjustment per Procedure 5.4.
15. Re-install the left and right cover sections as described in Procedure 7.1, then check the operation of the EFX as described in Section Four.

Procedure 7.14 - Replacing a Stairarm Pivot Block

Warning: Care must be taken when work is being performed in the area of the stairarms. Pinch points exist between the stairarm and ramp and between the stairarm and crankarm, when the rear covers are removed.

Procedure

1. Set the on/off switch in the “off” position, then unplug the power cord from the wall outlet.

WARNING

Before continuing with this procedure, review the Warning and Caution statements listed in Section One, Things You Should Know.

2. Remove the left and/or right cover sections as described in Procedure 7.1.
3. Remove the mounting bolt and nut that fastens the stairarm pivot block to the stairarm. (See Diagram 7.17)
4. Slide the stairarm off of the stairarm pivot block.
5. Remove the stairarm pivot block retaining ring from the crankarm pin. Slide the stairarm pivot block off of the crankarm pin. If the stairarm pivot block is being replaced because of excessive wear, check the condition of the crank arm pin, it may be necessary to replace the crankarm.

Diagram 7.17 - Stairarm Mounting

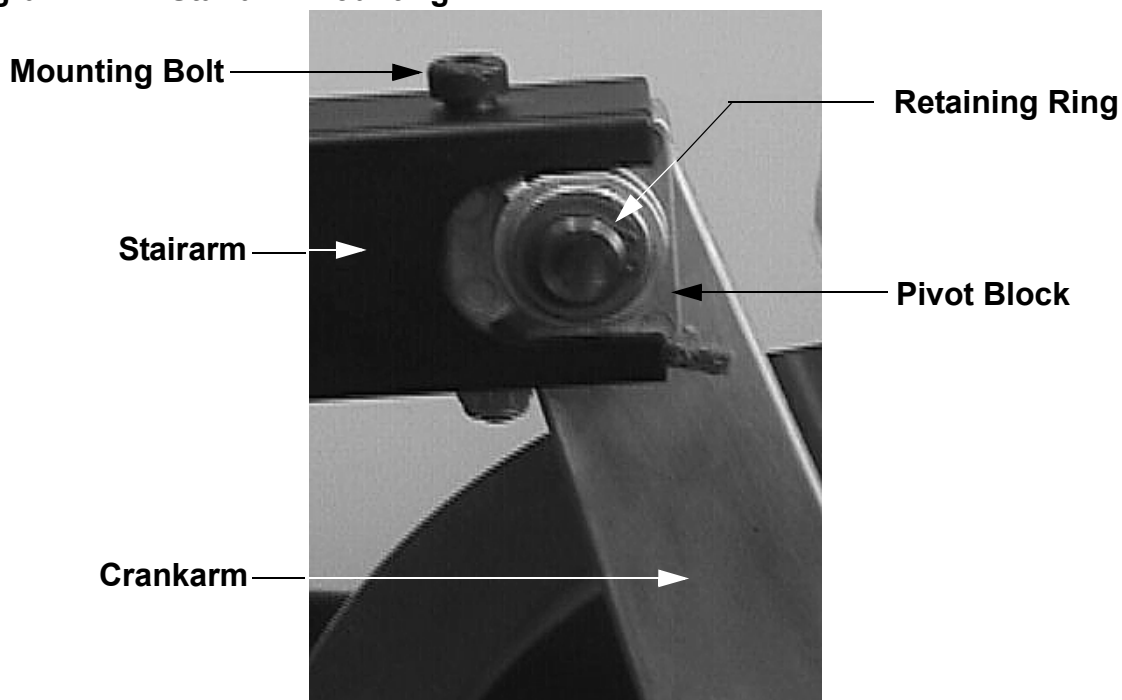

6. Slide the stairarm pivot block onto the crankarm pin and replace the retaining ring removed in step 5.
7. Slide the stairarm onto the stairarm pivot block. Install and hand tighten the stairarm pivot block mounting hardware. Torque the stairarm pivot block mounting bolt to 15 ft./lbs.
8. Replace the left and/or right cover sections per Procedure 7.1.

Procedure 7.15 - Replacing a Wheel Assembly

Warning: Care must be taken when work is being performed in the area of the stairarms. Pinch points exist between the stairarm and ramp and between the stairarm and crankarm, when the rear covers are removed.

Procedure

1. Set the on/off switch in the “off” position, then unplug the power cord from the wall outlet.

WARNING

Before continuing with this procedure, review the Warning and Caution statements listed in Section One, Things You Should Know.

2. Remove the screws from the wheel axle. If when removing the second wheel axle screw, the axle rotates and the screw does not unthread, insert a 5/32” allen wrench into the end of the axle from which the screw has been removed. The allen wrench will hold the axle while you remove the remaining screw. Remove the wheel assembly from the stairarm.

Diagram 7.18- Wheel Assembly

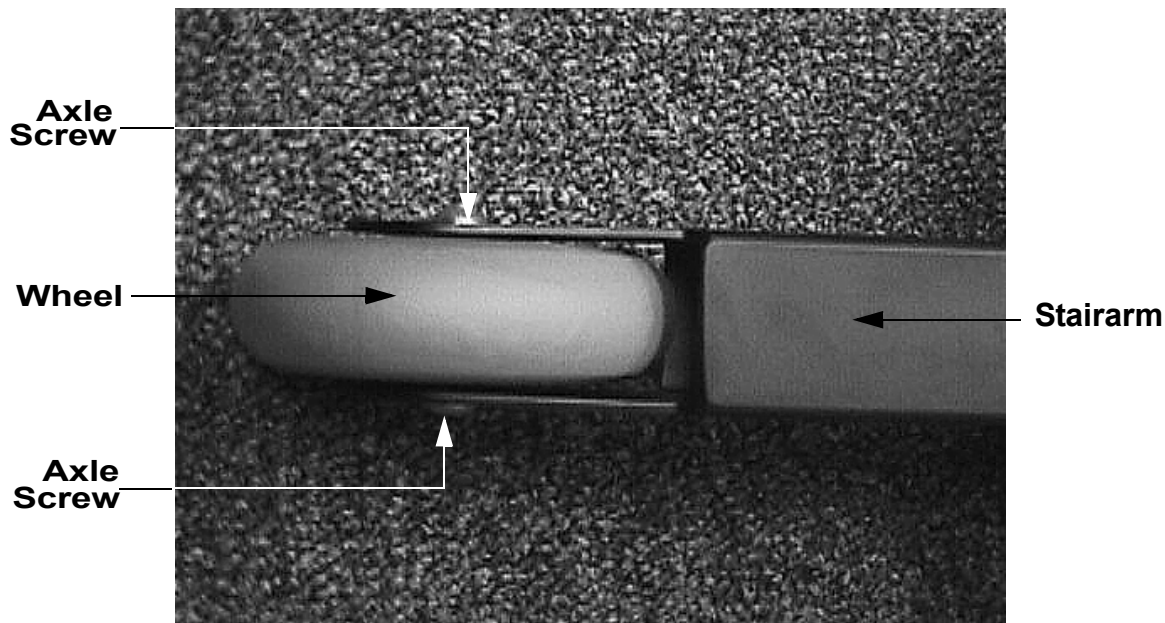

3. Set the replacement wheel in the stairarm and insert and hand tighten the wheel axle screws. Torque the wheel axle screws to 80 in/lbs.

Note: The wheel axle screws are equipped with a “loctite patch”. If the wheel axle screws have been inserted and removed more than two times, red loctite should be used on the wheel axle screws when they are re-installed.

Procedure 7.16 - Replacing a Stairarm Pedal

Warning: Care must be taken when work is being performed in the area of the stairarms. Pinch points exist between the stairarm and ramp and between the stairarm and crankarm, when the rear covers are removed.

1. Procedure

1. Set the on/off switch in the "off" position, then unplug the power cord from the wall outlet
2. Loosen and remove the two bolts that fasten the stairarm pedal onto the stairarm.
3. Remove the stairarm pedal from the stairarm.
4. Set the replacement stairarm pedal at it's mounting position on the stairarm.
5. Install and hand tighten the stairarm pedal mounting hardware removed in step 2. Torque the stairarm pedal mounting bolts to 11 ft./lbs.

Diagram 7.19 - Stairarm Pedal

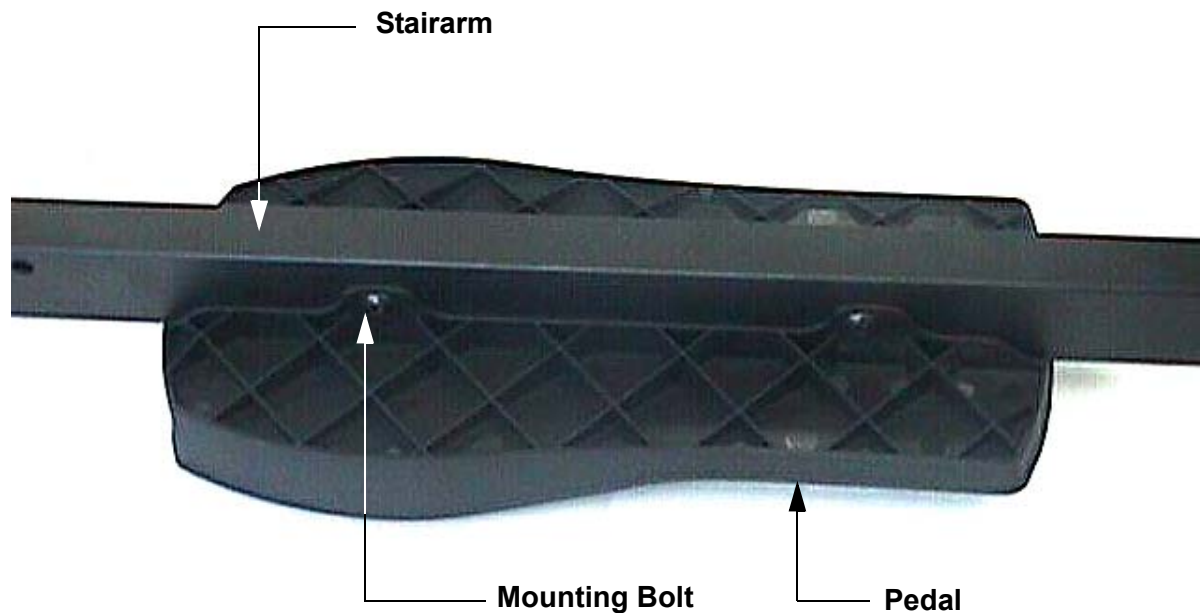

Procedure 7.17 - Replacing a Stairarm

Warning: Care must be taken when work is being performed in the area of the stairarms. Pinch points exist between the stairarm and ramp and between the stairarm and crankarm, when the rear covers are removed.

1. Procedure

1. Set the on/off switch in the “off” position, then unplug the power cord from the wall outlet.
2. Loosen and remove the two bolts that fasten the stairarm pedal onto the stairarm.
3. Remove the stairarm pedal from the stairarm.
4. Remove the left and/or right cover sections as described in Procedure 7.1.
5. Remove the mounting bolt and nut that fastens the stairarm pivot block to the stairarm. (See Diagram 7.17)
6. Slide the stairarm off of the stairarm pivot block.
7. Set the stairarm pedal at it’s mounting position on the replacement stairarm.
8. Install and hand tighten the stairarm pedal mounting hardware removed in step 2. Torque the stairarm pedal mounting bolts to 60 in/lbs.
9. Remove and replace the wheel per procedure 7.15
10. Slide the replacement stairarm assembly onto the stairarm pivot block. Install and hand tighten the stairarm pivot block mounting hardware. Torque the stairarm pivot block mounting hardware to 15 ft./lbs.
11. Replace the left and/or right cover sections per Procedure 7.1.

Procedure 7.18 - Replacing a Ramp Assembly

Warning: Care must be taken when work is being performed in the area of the stairarms. Pinch points exist between the stairarm and ramp and between the stairarm and crankarm, when the rear covers are removed.

1. Set the on/off switch in the “on” position. Press the **QUICK START** key, while striding on the unit raise the incline to level 17.
2. Set the on/off switch in the “off” position, then unplug the power cord from the wall outlet.
3. Remove the right and left rear covers per Procedure 7.1 and pivot both stairarms to the rear of the unit.
4. Remove the two bolts that fasten the lower rear portion of the ramp to the frame. See Diagram 7.20.

Diagram 7.20 - Lower Ramp Mounting



5. Remove the four bolts (two on top and two on the bottom) that fasten the upper end of the ramp to the lift motor yoke. See Diagram 7.21.
6. Carefully lift the ramp and slide it off of the lift motor yoke.
7. Slide the replacement ramp onto the lift motor yoke and hand start the four upper lift motor bolts removed in step 5. Hand start the two lower ramp mounting bolts removed in step 4. Torque the two lower ramp bolts to 25 foot pounds. Torque the four upper ramp mounting bolts to 240 inch pounds.

Diagram 7.21 - Upper Ramp Mounting

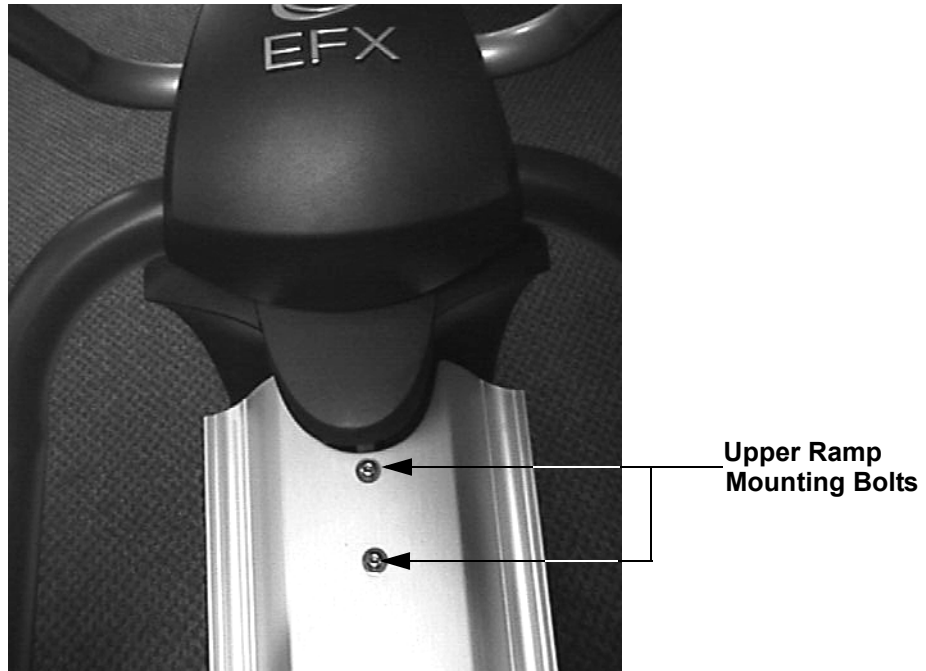

8. Rotate both stairarms forward and place them on the ramp tracks.
9. Replace the left and right rear covers per Procedure 7.1.

Procedure 7.19 - Replacing a Handlebar

1. Set the on/off switch in the “off” position, then unplug the power cord from the wall outlet.
2. Slide the lower handle bar boot up the handlebar to expose the lower handlebar mounting bolts. See Diagram 7.22.
3. Remove both of the lower handlebar mounting bolts. See Diagram 7.22.

Diagram 7.22 - Lower Handlebar Mounting

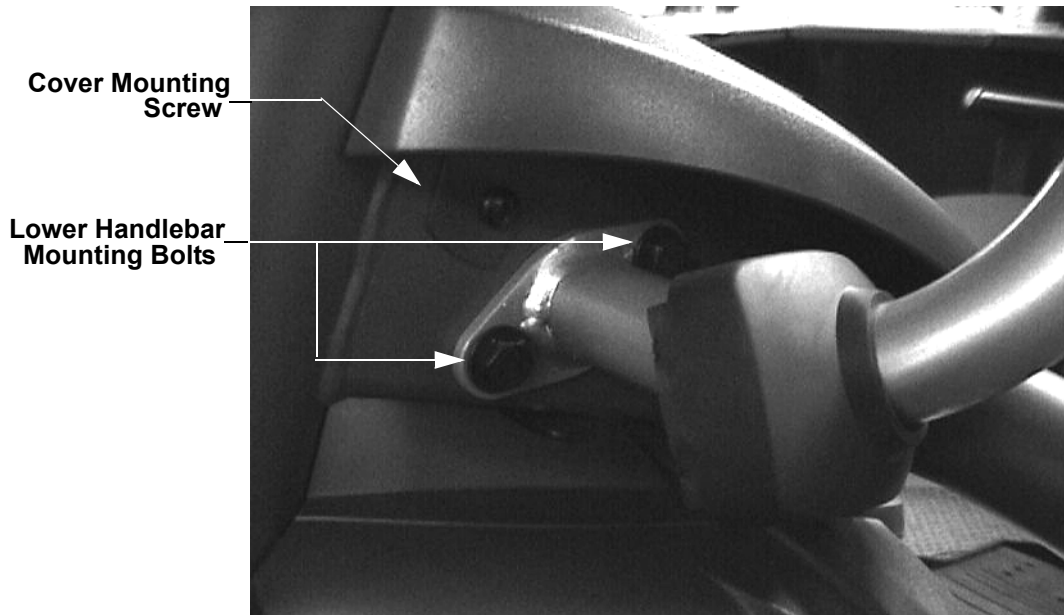

4. Remove the bolt that fastens the upper end of the handlebar in the handlebar clamp.
5. Slide the handlebar out of the handlebar clamp.
6. Set the replacement handlebar in its mounting position, and slide the handlebar into the handlebar clamp.
7. Align the lower end handlebar with its mounting holes. Hand start the lower handlebar mounting bolts removed in step 3.
8. Hand start the upper handlebar mounting bolt in the handlebar clamp.
9. Torque the lower handlebar bolts to 300 inch pounds and the upper handlebar bolt to 140 inch pounds.
10. Slide the handlebar boot into place so that it covers the lower handlebar mounting bolts.

Procedure 7.20 - Replacing a Input Belt Tensioner

Warning: Care must be taken when work is being performed in the area of the stairarms. Pinch points exist between the stairarm and ramp and between the stairarm and crankarm, when the rear covers are removed.

Procedure

1. Set the on/off switch in the “off” position, then unplug the power cord from the wall outlet.

WARNING

Before continuing with this procedure, review the Warning and Caution statements listed in Section One, Things You Should Know.

2. Remove the left and right cover sections as described in Procedure 7.1.
3. Remove the input belt tension mounting bolt and slide the input belt tensioner out of the frame.

Diagram 7.23 - Input Belt Tensioner

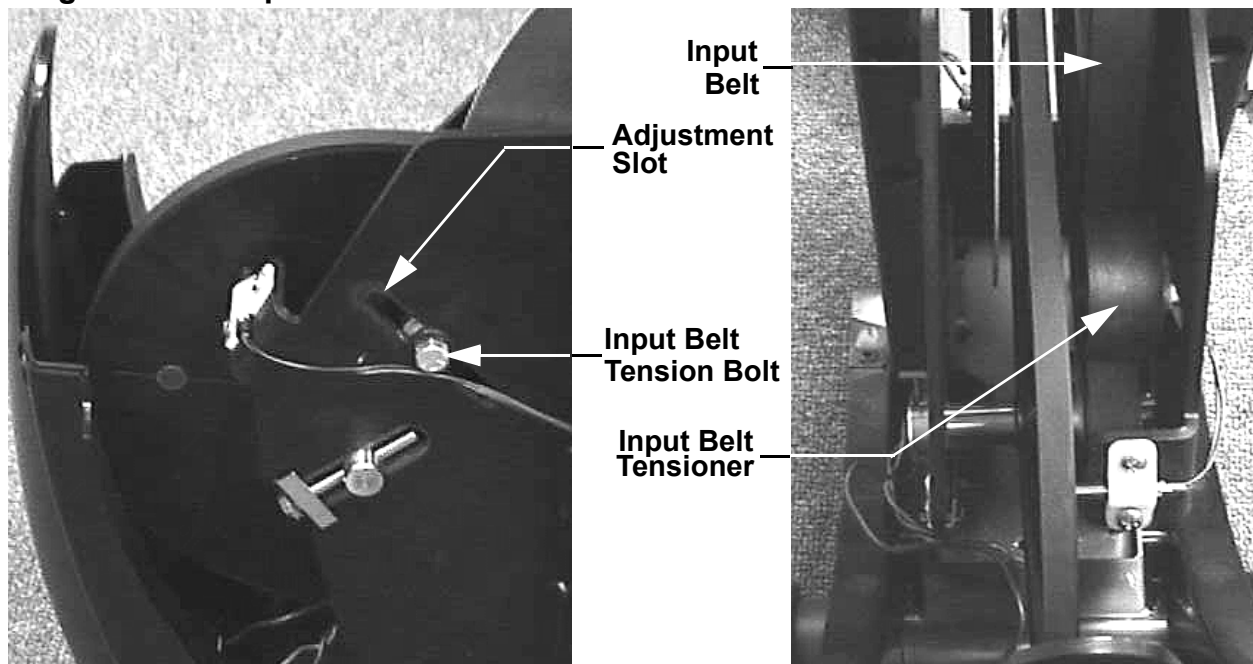

4. Loosely mount the new input belt tensioner in it's mounting position using the bolt removed in step 3.
5. Using your finger, press in on the center of the step up pulley belt to get a feeling of how much pressure it takes to deflect the belt a 1/4".
6. Check the input drive adjustment per Procedure 5.4.

Procedure 7.21 - Replacing a Main Column

1. Procedure

1. Set the on/off switch in the off position. Remove the A.C. line cord from the A.C. outlet.
2. Attach the anti-static wrist strap to your arm, then connect the ground lead of the wrist strap to the EFX frame.
3. Remove the four screws that secure the display housing front panel to the display backing plate.
4. Disconnect the heart rate cable (connector J1) and upper interconnect cable (connector J5) from the upper PCA. Remove the display housing front panel.
5. Remove the four screws that fasten the display backplate to the upper main column. Remove the display housing backplate.
6. Pry the end cap out the front of the frame base tube with a thin bladed screwdriver (See Diagram 7.6).
7. Carefully withdraw both cables and mid-point connector. Disconnect the upper interconnect cable from the mid-point connector. Carefully draw the upper interconnect cable out of the upper end of the main column. Set the cable aside to be re-installed later.
8. Remove the two screws that fasten the cover near the middle of the main column. Remove the cover. See Diagram 7.22.

Diagram 7.24 - Main Column

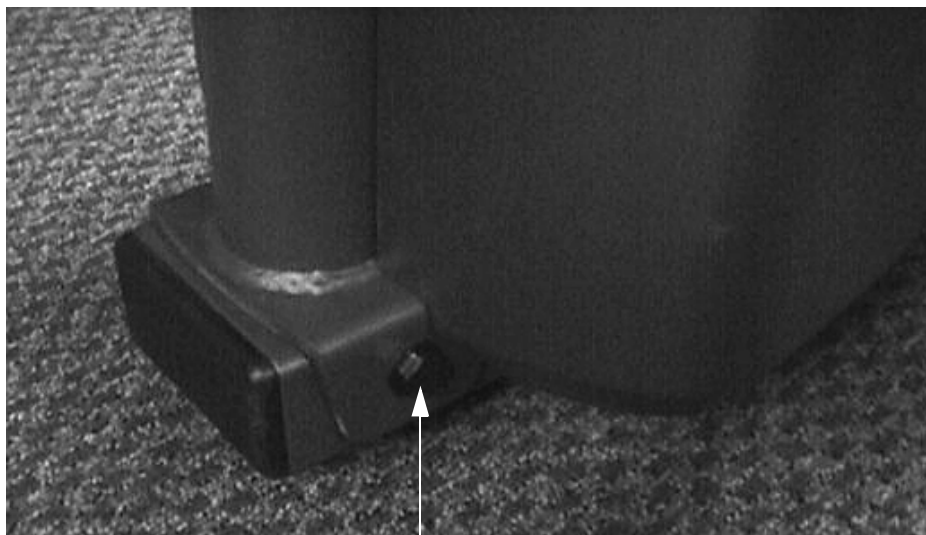

Lower Main Column
Mounting Bolt

9. Remove both handlebars per Procedure 7.19, steps 2-5.
10. Remove the left and right frame tube per Procedure 7.22, steps 1-4.
11. Remove the two bolts and washers that fasten the bottom of the main column to the frame base. See Diagram 7.24. Remove the main column.
12. Feed the upper interconnect cable into the replacement main column so that an end of the cable protrudes from both ends of the main column.
13. Set the main column at its mounting location with the lower end of the upper interconnect cable in the access hole in the frame base. Replace bolts and washers removed in step 12 and torque them to 240 in./lbs.
14. Replace the left and right frame tubes per Procedure 7.22, steps 5-7.
15. Rotate the right hand handlebar with upper pivot into its mounting position. Thread the upper pivot into the main column and torque it to 100 ft./lbs.
16. Repeat the procedure in step 16 with the left hand handlebar and upper pivot.
17. Replace the cover with the hardware removed in step 8.
18. Connect the lower end of the upper interconnect cable to the mid-point connector. Careful push the mid-point connector and cables into the frame tube. Replace the end cap.
19. Feed the upper end of the upper interconnect cable through access hole in the display housing backplate. Set the display housing backplate at its mounting position and fasten it with the screws removed in step 5.
20. Connect the upper interconnect cable to the J5 connector on the upper PCA. Set the display housing front panel at its mounting location and fasten it with the hardware removed in step 3.
21. Insert the A.C. line cord in the A.C. outlet and set the on/off switch in the on position. Thoroughly test the EFX per Section Four.

Procedure 7.22 - Replacing a Frame Tube

1. Procedure

1. Set the on/off switch in the off position.
2. Remove the two screws that fasten the cover near the middle of the main column. Remove the cover.
3. Remove the four bolts and washers that fasten the lower end of the frame tube to the frame base.

Diagram 7.25 - Frame Tube Mounting

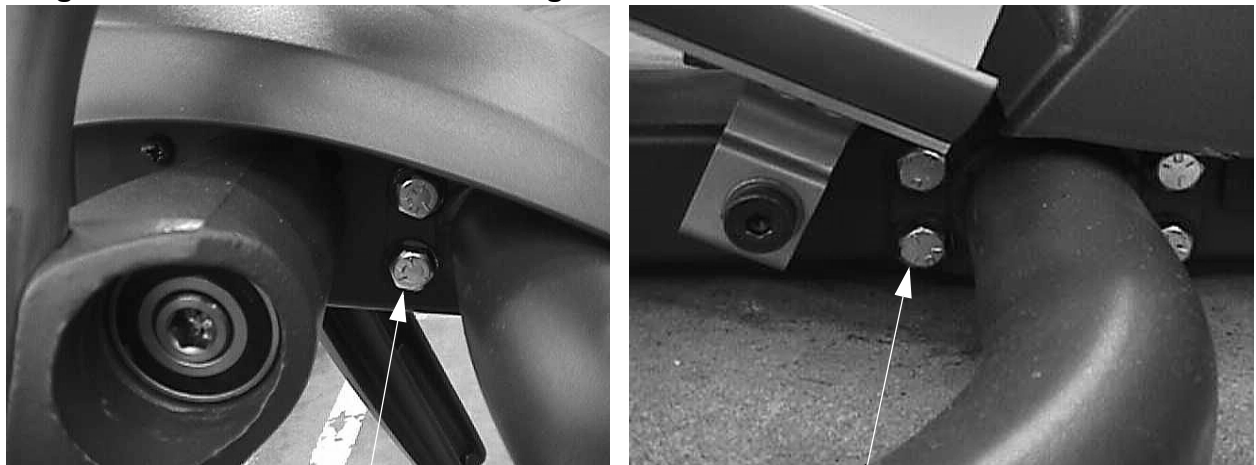

Upper Mounting Bolt

Lower Mounting Bolt

4. Remove the four bolts and washers that fasten the upper end of the frame tube to the main column. Remove the frame tube.
5. Set the replacement frame tube at its mounting position and hand start the bolts with washers at the upper end of the frame tube. Hand start the bolts with washers at the lower end of the frame tube. Torque the upper front two bolts to 300 in./lbs., the upper rear bolts to 240 in./lbs. and the lower four bolts to 300 in./lbs. See Diagram 7.25.
6. Set the cover in its mounting and fasten it with the two screws removed in step 2.
7. Set the on/off switch in the on position and thoroughly test the EFX per Section Four.

Procedure 7.23 - Replacing a Ramp Mounting Bracket

Warning: Care must be taken when work is being performed in the area of the stairarms. Pinch points exist between the stairarm and ramp and between the stairarm and crankarm, when the rear covers are removed.

Procedure

1. Set the on/off switch in the off position.
2. Remove the front, top, left and right rear cover sections per Procedure 7.1.
3. Remove three bolts, washers and single nut that fasten the right stairarm connector to the right stairarm. Remove three bolts, washers and single nut that fasten the left stairarm connector to the left stairarm.
4. Rotate both stairarms to the rear, so that they are resting on the floor to the rear of the EFX.

Diagram 7.26 - Ramp Mounting Bracket

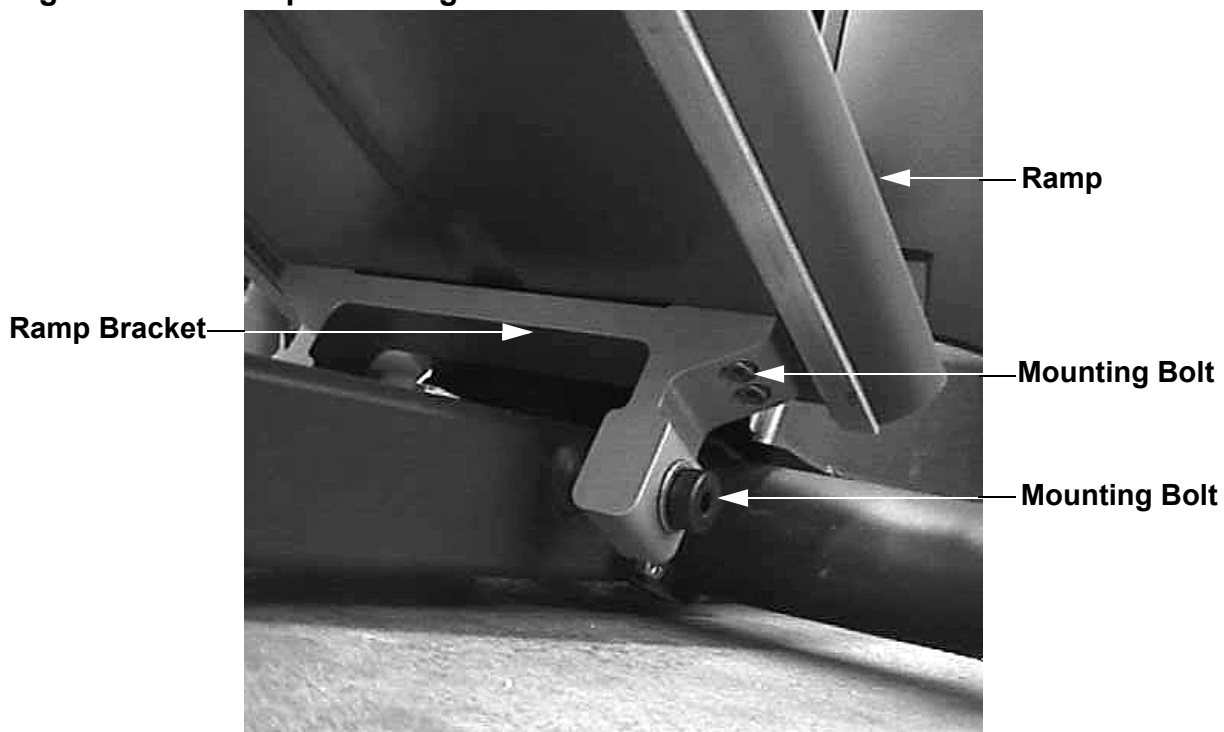

5. Remove the screw that fastens the ramp end cap to the ramp. Remove the ramp end cap.
6. Remove the four bolts that fasten the ramp to the rear ramp bracket.

7. Remove two bolts, four washers and two nuts that fasten the ramp to the front ramp support.
8. Remove the ramp from the EFX.
9. Remove the two bolts, wave washers and shims that fasten the ramp mounting bracket to the frame. Remove the ramp mounting bracket.
10. Set the replacement ramp mounting bracket at its mounting position. Fasten the ramp mounting bracket with the hardware removed in step 8, slide the wave washer onto the bolt and then the shim. Torque the bolts to 25 ft./lbs.
11. Set the replacement ramp in its mounting position, replace the bolts washers and nuts removed in step 6. Do not tighten the bolts at this time.
12. Replace the four bolts and washers removed in step 5 that fasten the ramp to the rear ramp bracket.
13. Torque the four bolts between the ramp and rear ramp bracket to 12 ft./lbs. Torque the two bolts between the ramp and the front ramp support to 20 ft./lbs.
14. Replace the ramp end cap with the screw removed in step 4.
15. Rotate both stairarms forward so that they are resting on the ramp.
16. Set the replacement right stairarm connector at its mounting position and slide the secondary link onto the right stairarm connector. Replace, but do not tighten the hardware removed in step 3. Torque the two bottom bolts to 50 in./lbs. Torque the horizontal bolt to 11 ft.lbs. Set the replacement left stairarm connector at its mounting position and slide the secondary link onto the left stairarm connector. Replace, but do not tighten the hardware removed in step 3. Torque the two bottom bolts to 50 in./lbs. Torque the horizontal bolt to 11 ft.lbs.
17. Replace the front, top, left and right cover sections per Procedure 7.1.
18. Thoroughly, test the EFX per Section Four.

Procedure 7.24 - Replacing a Rear Cover Support

Procedure

1. Set the on/off switch in the off position. Remove the A.C. line cord from the A.C. outlet and from the power entry module.
2. Remove the top, left and right cover sections per Procedure 7.1.

Diagram 7.27 - Rear Cover Support

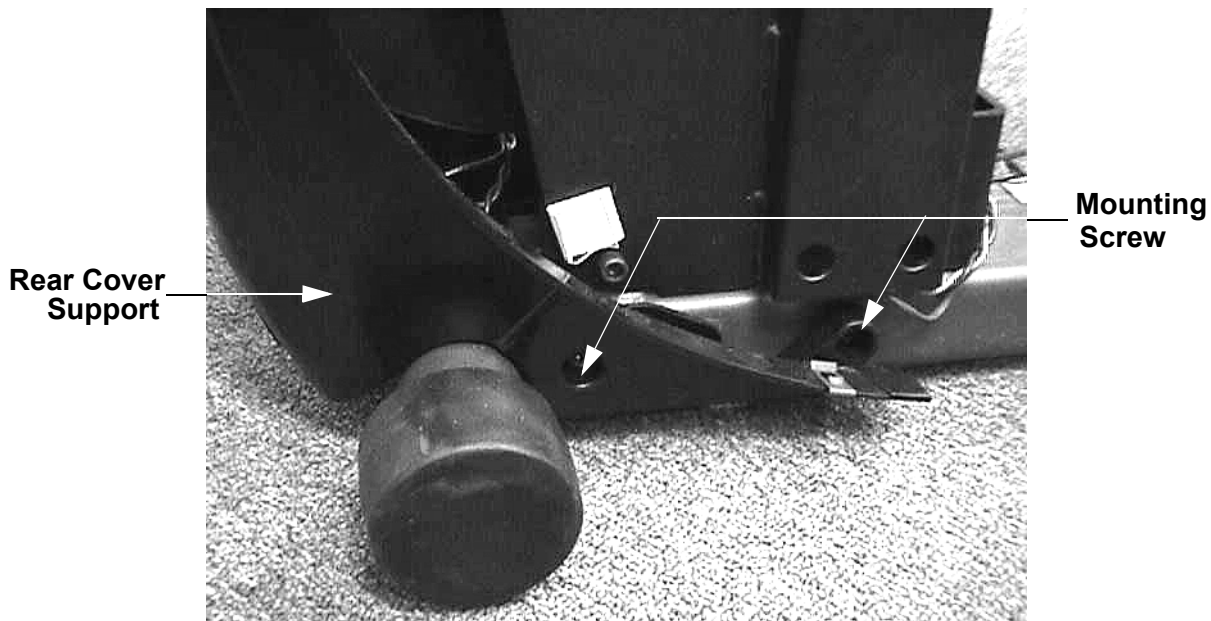

3. Remove the blue wire from terminal D, the brown wire from terminal A and the green wire from the ground terminal of the power entry module.
4. Remove the two screws that mount the power entry module to the rear cover support.
5. Remove the four screws that fasten the rear cover support to the frame base. Remove the rear cover support.
6. Set the replacement rear cover support at its mounting position. Fasten it to the frame base with the four screws removed in step 5.
7. Set the power entry module at its mounting position in the rear cover support and secure the power entry module with the screws removed in step 4.
8. Replace the wires removed in step 3. Connect the blue wire to terminal D, the brown wire to terminal A and the green wire to the ground terminal of the power entry module.

9. Replace the top, left and right cover sections per Procedure 7.1.
10. Insert the A.C. line cord in the power entry module and the A.C. outlet.
11. Set the on/off switch in the on position and test the EFX per Section Four.

Procedure 7.25 - Replacing a Power Entry Module Fuse

Procedure

1. Set the on/off switch in the off position. Remove the A.C. line cord from the A.C. outlet and from the power entry module.
2. Using a thin bladed screwdriver, carefully pry the fuse access door open (See Diagram 7.28 or Diagram 7.29).

Diagram 7.28 - Power Entry Module Fuse (serial codes F8 and SS)

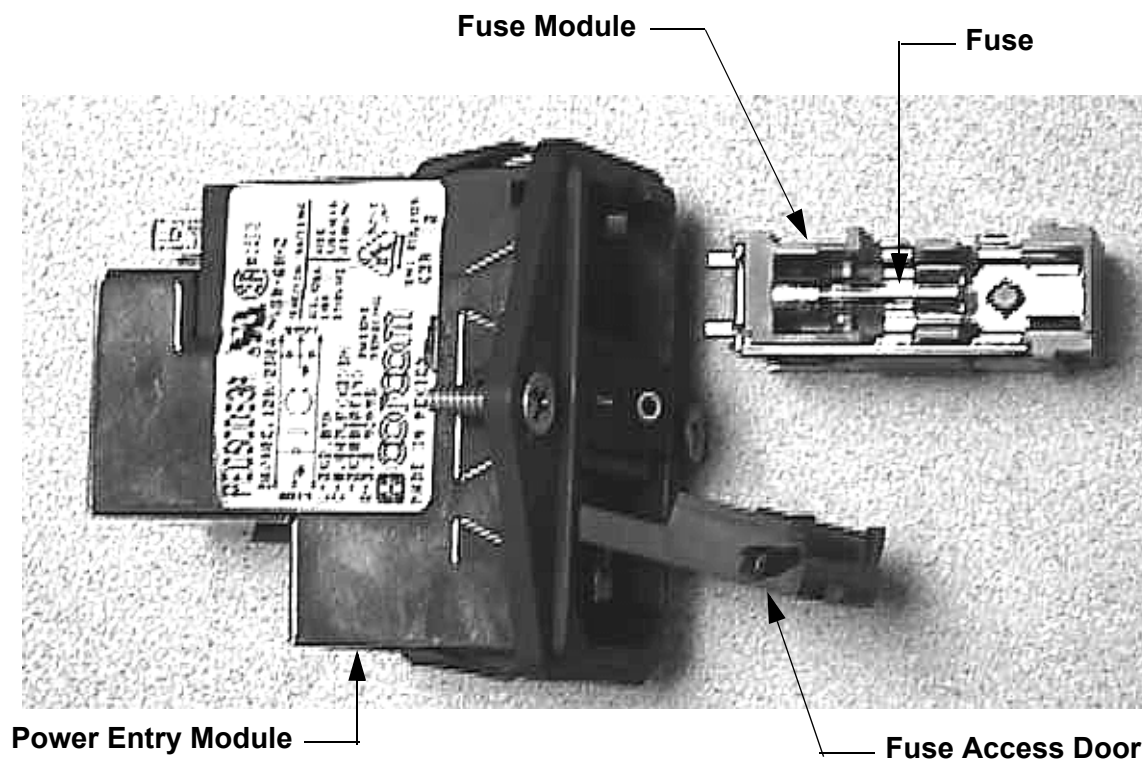

3. Using a thin bladed screwdriver, carefully pry the fuse module out of the power entry module.
4. The fuse module contains two fuses, carefully remove one or both fuses out of the fuse module, as required.
5. Insert the replacement fuse(s) into the fuse module. Use only 2 amp time delay fuses.
6. Slide the fuse module back into the power entry module and close the fuse access door.
7. Insert the A.C. line cord in the power entry module and the A.C. outlet.

Diagram 7.29 - Power Entry Module Fuse (serial code A998)

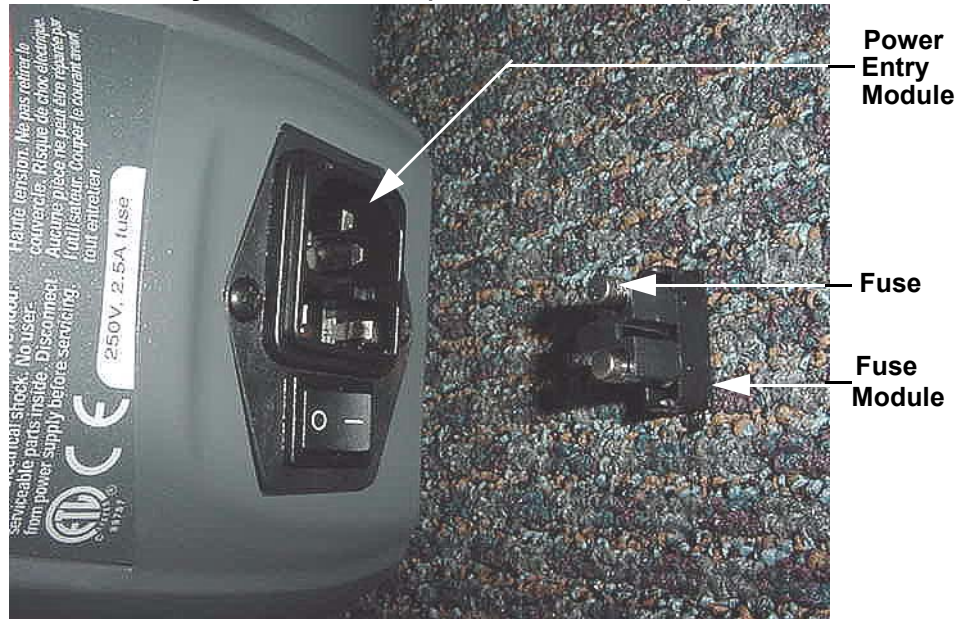

Set the on/off switch in the on position and test the EFX per Section Four.

Procedure 7.26 - Replacing a Lift Motor

1. Set the on/off switch in the “on” position. Press the **QUICK START**, while striding on the unit, raise the incline to level 17.
2. Set the on/off switch in the “off” position. Remove the A.C. line cord from the A.C. outlet and from the power entry module.
3. Remove both front cover halves.
4. Remove the left and right rear covers. Rotate both stairarms to the rear of the unit.
5. Remove the four bolts that fasten the upper end of the ramp to the lift motor yoke. See Diagram 7.21.
6. Carefully, draw the lift motor yoke out of the ramp and lay the ramp down against the frame.
7. Remove the retaining bolt and nut at the top end of the lift motor drive screw. See Diagram 5.5. Thread the lift motor yoke off of the lift motor drive screw.
8. Disconnect the lift motor connector and remove the screw that retains the lift motor frame ground. See Diagram 7.30.

Diagram 7.30 - Lift Motor Mounting

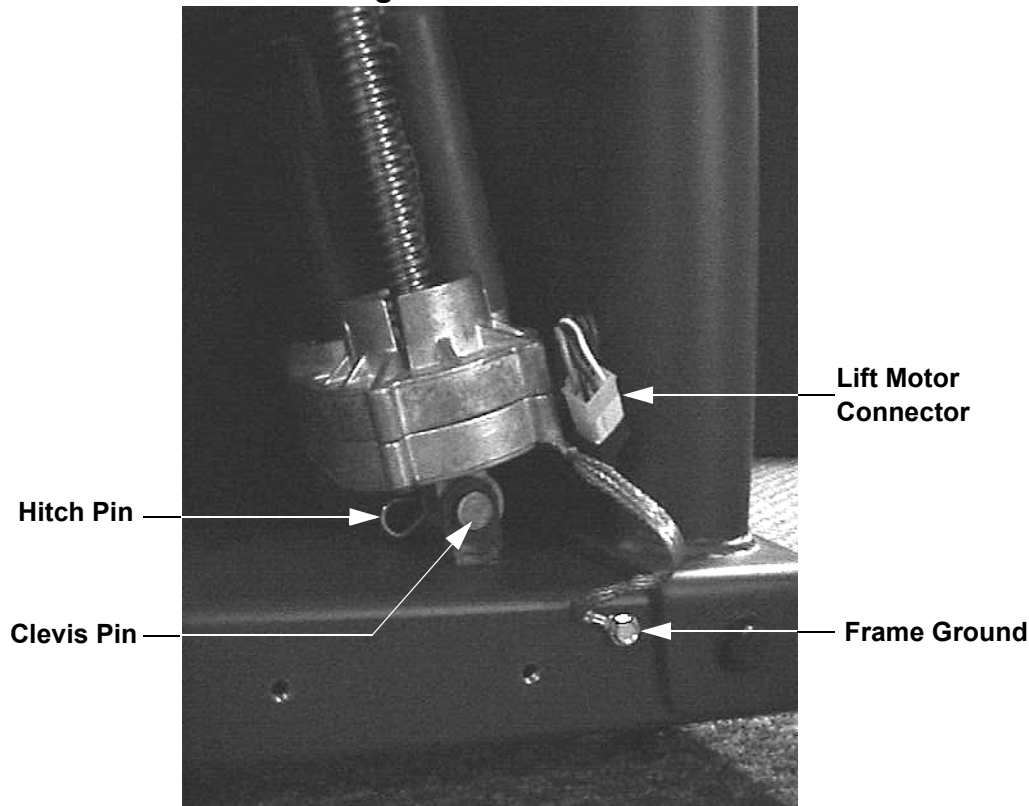

9. Remove the hitch pin and clevis pin from the lower end of the lift motor and remove the lift motor from the unit.
10. Thread the lift motor yoke onto the replacement lift motor. Insert the retaining bolt, removed in step 7, into the replacement lift motor and secure it with the retaining nut.
11. Set the replacement lift motor in its mounting position and secure it with the clevis pin and hitch pin removed in step 9.
12. Reconnect the lift motor connector to its mating connector. Fasten the frame ground connector to the frame with the screw removed in step 8.
13. Calibrate the lift motor per Procedure 5.3, steps 4-9.
14. Replace both front cover halves.

Procedure 7.27 - Replacing the PROM

Anti-static kits (part number 20024-101) can be ordered from Precor.

1. The PROM and the associated printed circuit assembly (PCA) are static sensitive. Anti-static devices must be used and all anti-static precautions must be followed during this procedure.
2. Remove the printed circuit assembly per its associated procedure.
3. Currently we are using two styles of IC software packages. they are a 28 pin dual in line package (DIP28) and a forty-four pin square package (PLCC44). Each of these packages should be removed with a proper IC removal tool (see the illustrations below)



4. The IC's may inserted into their socket by hand by carefully aligning the notch on the IC with the notch on the IC socket and carefully pressing the IC into its socket. See the illustrations below for the alignment notches. Care must be taken that the IC legs on a DIP28 are all aligned in the socket to prevent the legs from bending when inserted. The PLCC44 IC must be carefully aligned squarely in its socket or it will not insert. Do not force the IC into its, socket. If it does not insert easily, remove the it and re-align it in its socket.

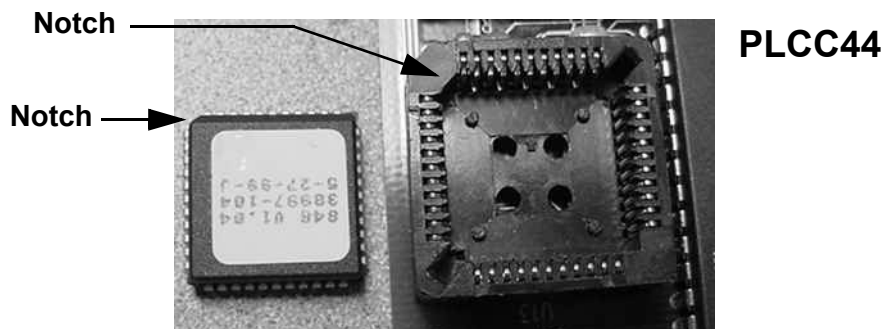
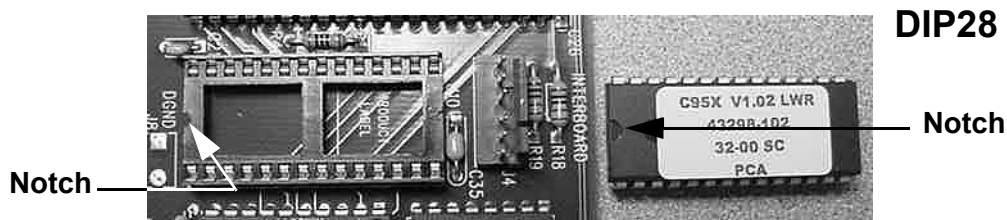

Wiring Diagram 8.1 - 5.21i

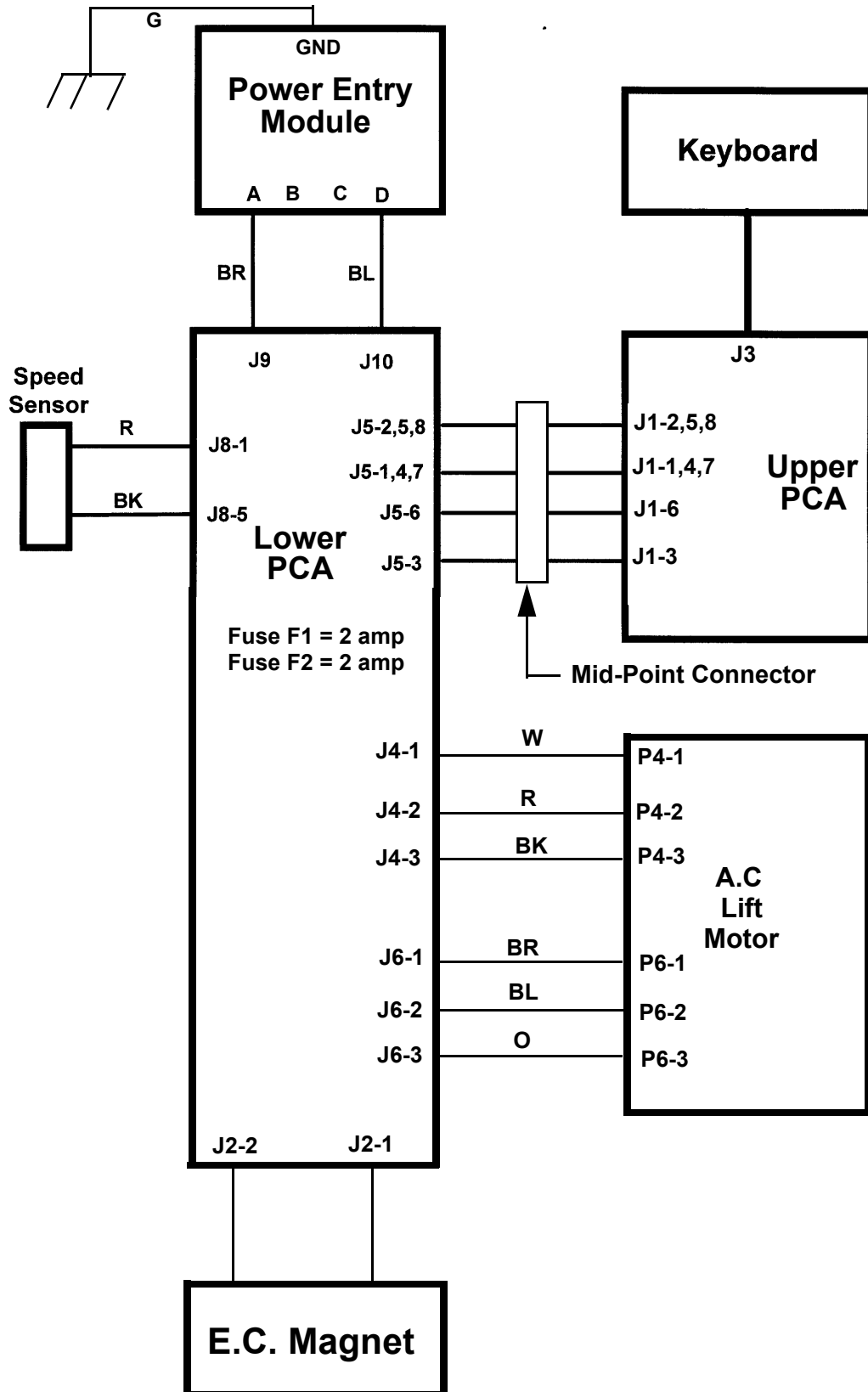

Block Diagram 8.2 - 5.21i

PRECOR USA

5.21i-120 EFX

