



StairMaster®

SC916 StairClimber



Owner's Manual

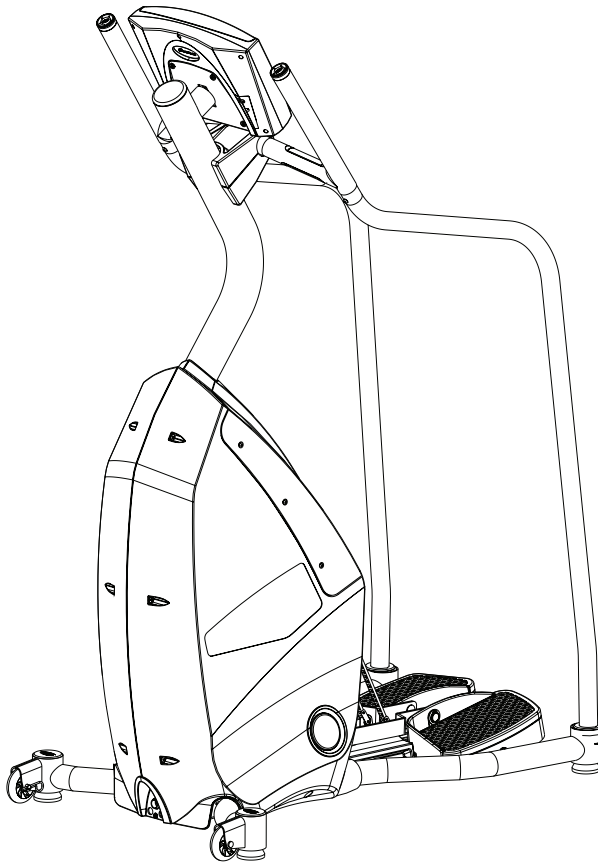

Nautilus® Bowflex® Schwinn® Fitness StairMaster® Universal® Nautilus Institute®

a brand of **NAUTILUS** Inc.

001-7200-021208A





Introduction

Thank you for purchasing the StairMaster® Commercial Series SC916 StairClimber a brand of Nautilus, Inc. For more than 30 years Nautilus, Inc. has been producing the world's finest fitness equipment used in health clubs and homes around the globe. We hope this product exceeds your expectations and proves to be a valuable tool.

Please carefully read through this manual to familiarize yourself with the operation of your new SC916 StairClimber. Doing so will help to insure that you get the most out of your SC916 StairClimber, enjoying safe and effective workouts in the many miles ahead.

Nautilus, Inc.
World Headquarters
16400 SE Nautilus Drive
Vancouver, WA 98683

(800) NAUTILUS (800-628-8458)
nautilus.com





Table of Contents

Product Specifications	4
Safety Warnings & Labels	5
Getting Started	7
Guidelines for Getting Off and On the StairClimber	7
Operations	8
Display Definitions and Functions	8
Key Functions	10
Programs	12
Workout Program Keypad	12
Quick Start Program	14
Manual Program	14
Fat Burner Program	15
Calorie Burner Program	17
Intervals Program	18
Heart Rate Zone Trainer Program	19
Nautilus® Fit Test Program	21
Calorie Goal	26
HR Intervals Program	27
Random Play Program	28
Custom Intervals Program	28
CPAT Program	29
Workout Program Options	30
Heart Rate Monitoring	32
Telemetry Heart Rate	32
Maintaining the Transmitter Belt	33
Contact Heart Rate	33
Heart Rate Priority	34
Console Codes	36
Default and Custom Codes	37
Machine Status Codes	38
Diagnostic Codes	39
Configuration Codes	41
Maintenance	43
Moving Your Machine	43
Schedule	44
Checking the Battery Charge	45
Recharging the Battery Backup	45
Battery Disposal & Recycling	45
Warranty Information	46
Contacting Nautilus, Inc.	48





Product Specifications

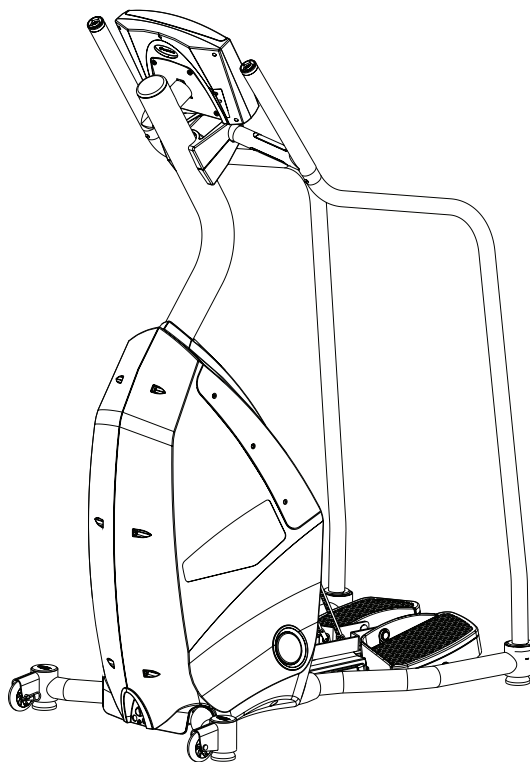

Model SC916

Dimensions: 27" W x 43" L x 68" H (68 cm x 109 cm x 173cm)

Unit Weight: 150 lbs (68 kg)

Shipping Package Weight: 178 lbs (81 kg)

Workout Area: 50" W x 81" L (127 cm x 205.74 cm)

Input Power Rating: 9V DC 1.00 Amps

External Power Adapter Ratings:

USA & Canada, 120V 60 Hz input, 9V DC 1.5 A output

Japan, 100V 50-60 Hz input, 1.5 A output

International (EU & Australia/New Zealand), 230V (or 220-240V) 50 Hz input, 9V DC 1.0 A output

Max user weight: 300lbs (136 kg)





Safety Warnings

 This icon means a potentially hazardous situation which, if not avoided, could result in death or serious injury.

Before using this equipment, obey the following warnings:

 Read and understand the complete Owner's Manual.
Read and understand all Warnings on this machine.

- If this machine is being used in a commercial setting, end users may not have access to this Owner's Manual. It is the responsibility of the facility to instruct users as to the proper usage of the equipment, as well as making them aware of potential hazards.
- Keep children away from this machine. Watch them closely when near the machine. Moving parts that appear dangerous to adults may not appear so to children.
- Consult a physician before starting an exercise program. Stop exercising if you feel pain or tightness in your chest, become short of breath, or feel faint. Contact your doctor before using the machine again.
- Examine this machine for loose parts or signs of wear. Pay special attention to the pedals. Contact Nautilus® Customer Service for repair information. Use only genuine StairMaster® replacement parts supplied by Nautilus, Inc.
- Set up and operate your StairClimber on a hard, level surface.
- Do not wear loose clothing or jewelry while exercising.
- Maximum user weight limit: 300 lb. (136 kg). Do not use if you are over this weight
- Stabilize the pedals before stepping on them and use caution when stepping off the machine.
- Keep at least 19 inches (50 cm) clear area around the machine. This is the recommended safe distance for access and passage around and emergency dismounts from the machine.
- Warn bystanders to keep a safe distance, at least 3 feet (1 m). Do not allow anyone to touch the operator while the machine is in motion.
- Do not over exert yourself during exercise. Do not try to exercise with more resistance than you can physically handle.





Safety Warning Labels

BEFORE USING YOUR PRODUCT: Find and read all warning labels located on the StairMaster® Commercial Series SC916 StairClimber, prior to using your product. Be sure to replace any warning label if damaged, illegible, or missing. If you need replacement labels, please call a Nautilus® Representative at (800) 628-8458 (North America) or (41) (26) 460 77 77 (International office).

Label 1: General warning label.

Location: Affixed to the lower front of the left side cover (see Figure 1).

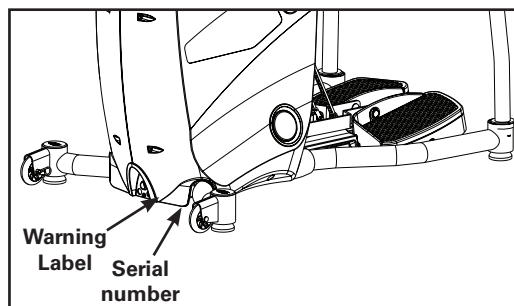

Figure 1

Label 2: General exercise warning label.

Location: Affixed to the mast below the console (see Figure 2).

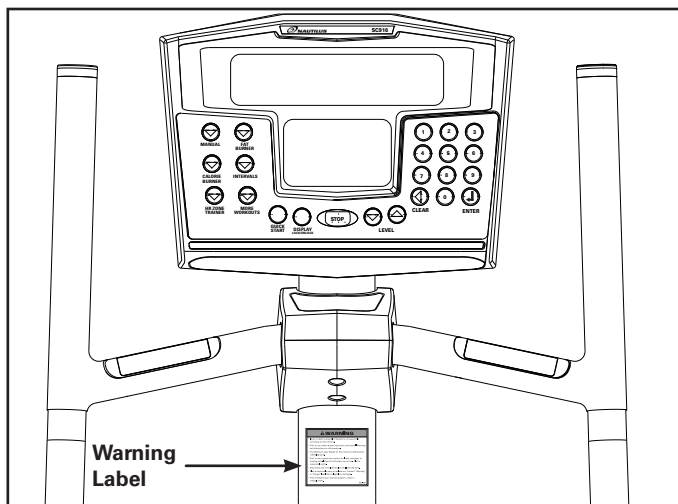

Figure 2





Getting Started

Note: Throughout this manual, all references to the left or right side and to the front or back, are made as if you were on the machine, ready to exercise.

GUIDELINES FOR GETTING ON AND OFF THE SC916 STAIRCLIMBER

Instruct each user in the following guidelines for getting on and off the StairClimber.



To avoid injury, please carefully follow the instructions.

1. You should see the “SELECT WORKOUT” message on the display.
2. Select the MANUAL exercise program so you can control the pace of your first workout and get used to the exercise motion. Press [MANUAL] and then press [ENTER].
3. The console will prompt you to enter your body weight. Enter your weight in pounds (or kilograms if the console is set to metric units). Correct entry errors by pressing [CLEAR] before you press [ENTER].
4. The console will prompt you to enter your step rate. Enter your desired step rate from 24 (very easy) to 162 (extremely hard). First time users may want to select a low step rate, for example, 24. Correct entry errors by pressing [CLEAR] before you press [ENTER].
5. The console will prompt you to enter the workout time in one-minute increments between 5 and 99 minutes. Press [1], [0], [ENTER] to exercise for ten minutes. After time is entered, the console will display “ENJOY WORKOUT” and your program will begin. If you do not start exercising within 30 seconds, the console will return to the start screen and shut down.
6. Begin pedaling so the pedals do not hit the ground during the workout. When you begin to exercise, the MANUAL program starts at the level you selected during data entry.
7. As you become comfortable with the exercise motion, press [LEVEL: ↑] and [LEVEL: ↓] to adjust the step rate.
8. Relax while exercising.
9. Before stepping off the StairClimber, stop and let the pedals slowly bring you to the floor. Use the Side rails for support and lift one foot slowly until the pedal arm contacts the upper stop. Place that foot on the floor. Repeat for the other foot. Do not let the pedals slam into the upper stops, since this may cause unnecessary wear and tear.



Operation

UNDERSTANDING THE DISPLAY AND CONTROLS

The SC916 console is a computerized panel used to operate the SC916 StairClimber, display workout data and operational status . Take time to read through and familiarize yourself with the operation of the SC916 StairClimber, and the location of all keys, to take full advantage of all of your machine's workout options.

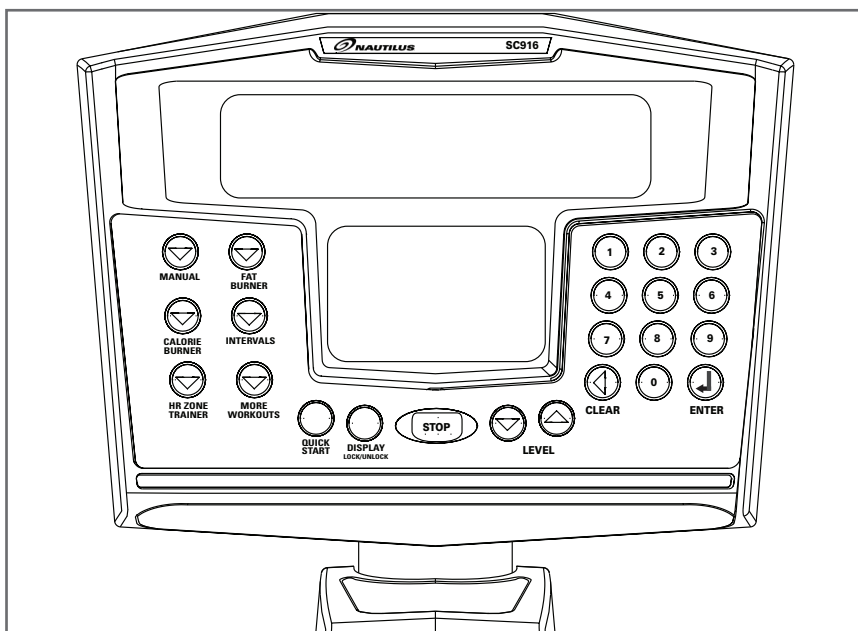

DISPLAY DEFINITIONS AND FUNCTIONS

Computer Display and Functions:

TIME

The selected workout time is displayed in the upper left section of the upper display window. In most of the workouts, the timer will count down, in minutes and seconds, until the workout is finished or stopped. If (0) is entered in the (MANUAL) or (HR ZONE TRAINER) workout, the timer will count up.

INTERVAL TIMER The interval timer is displayed in the lower display, upper left corner. The interval timer counts down the remaining time within each interval.



Operation

STEP RATE Pressing the ↑ key increases the workload intensity and pressing the ↓ key decreases the workload intensity.

 **User should consult a physician to determine an appropriate Target Heart Rate (THR) in which to exercise, based on age, weight and physical condition. While Nautilus® provides some THR ranges, these are only approximations and should not be viewed as a medical recommendation.**

HEART RATE Current Heart Rate (HR), in Beats Per Minute (BPM), is displayed next to the heart icon on the lower display.

Percentage of Maximum HR - An approximation of maximal HR is calculated based on the latest American College of Sports Medicine predictive equation as follows:

$$\text{Max Heart Rate} = 215 - (\text{Age} * .75)$$

Percentage of maximum HR will only be shown in HRC programs.

Example: For a person 40 years of age, max HR is estimated as $(215 - (40 \text{ (age)} * .75) = 185$. 185 BPM would be the approximate maximum HR for a 40-year-old user. If the user works out at 140 BPM, then 76% $(140 / 185 = 76\%)$ will be displayed in the upper left corner of the lower display area. This means that the 40-year-old user working at 140 BPM is at 76% of their maximum HR.

(See the Heart Training programs for more information.)

DISTANCE Provides a cumulative total of the equivalent distance, in miles (or kilometers if your display is set to metric units), you have traveled.

CALORIES Provides a current total of the number of calories burned during a workout.

Note: This number is only an approximation as a user's caloric expenditure will vary significantly based on a person's age, gender, weight and metabolism.

CALORIES/HOUR Provides the rate at which calories are burned per hour at the current resistance level and steps per minute.

SPEED Displays the step rate in steps per minute (SPM).



Operation

WATTS During a workout, this statistic displays the power output at the current RPM and intensity level, displayed in watts (746 watts = 1 hp).

METs MET (multiple of the resting metabolic rate) indicates the relative energy cost of exercise. While you are sitting quietly, your body consumes oxygen at the rate of 1 MET or about 3.5 milliliters per kilogram of body mass per minute. When you exercise, your body needs more oxygen in order to function. For example, exercising at 10 METs requires ten times the resting rate of oxygen consumption, or about 35 milliliters per kilogram per minute. During a workout, the display shows the current MET level. During the workout summary, the average MET level is displayed. During your workout, keeping track of the METs will show you how hard you are working—the higher the MET level, the harder you are working.

WORKOUT PROFILE The dot-matrix area of the display shows the actual course profile of the selected exercise program. The taller the column, the higher the step rate and/or METs for that interval. The flashing column shows your current interval.

KEY FUNCTIONS

Display LOCK / UNLOCK - Statistics Key

During the exercise program, the Display LOCK / UNLOCK key is used to track workout statistics which are shown in the text line of the display window. When a workout is started, the display is in an unlocked mode and the various exercise statistics will scroll in order. Press the [DISPLAY] key once to turn off the scan feature and show the current statistic in the display window. Press the [DISPLAY] key a second time and the scan feature will turn back on to scroll through the different statistics.

When in the Display Unlock mode, the console will cycle through the following statistics in order: Miles, Calories/Hour, Steps/Min, Floors, Watts, METs.

At the completion of a workout, the statistic averages are calculated based on the accumulation of data during the workout program.



Operation

QUICK START KEY The Quick Start Key provides an immediate start to a workout session without having to provide any user information.

LEVEL (STEP RATE) UP & DOWN KEYS The exercise Step Rate may be changed at any time during a workout. Pressing the **↑** key increases the step rate and pressing the **↓** key decreases the step rate. After the first press of a Level key, the text line will show the target step rate. Further presses will increase or decrease the step rate.

STOP KEY Press the STOP Key any time you want to pause the workout program for up to 2 minutes. Press the STOP Key a second time, and the workout statistics will be displayed, then the console will return to the "SELECT WORKOUT" prompt.

NUMERIC KEYPAD (0-9) The numeric keypad is located on the right side of the console. During program setup, this keypad allows you to quickly enter requested information such as Time, Age, Intensity Level, Weight, and HR.

Enter: The ENTER Key confirms workout selections and stores the information used by the console to calculate workout statistics.

Clear: During data entry, the CLEAR Key erases information from the console memory and backs up to the previous data entry prompt.



Operation

PROGRAMS

The StairMaster® Commercial Series SC916 StairClimber has a wide variety of programming options with a great amount of flexibility to allow anyone of any fitness level to use.

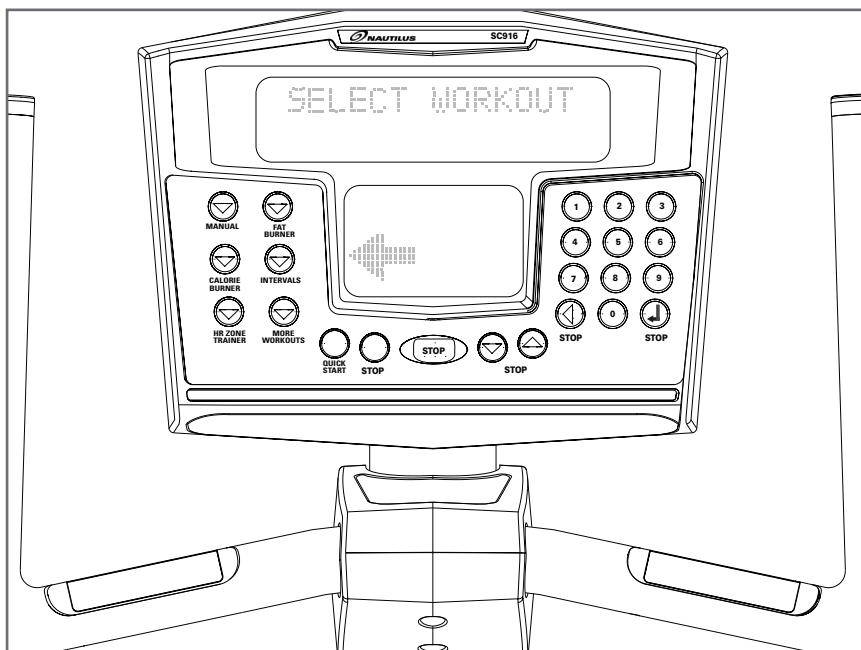

Workout Program Keypad

The workout program keypad is located to the left of the display. There are six workout program keys, including a More Workouts key with multiple advanced program options.

While the console is in the “SELECT WORKOUT” mode, press one of the exercise program keys to preview the desired workout. After selecting the desired workout, simply follow the prompts to enter the required user data for that program.

When entering data, the user can select the standard default values by pressing [ENTER] at the display prompt without first typing data. This will set up the console with the following default data:



Operation

STEP RATE: 41

CHR PERCENT: 70

WEIGHT: 175 lbs. (80 kg)

INTENSITY LEVEL: 3

AGE: (HR Zone Trainer program only) 40 years

WORKOUT TIME: The default time in the programmed workouts and Quick Start is 20 minutes. The Manual and HR Zone Trainer programs do not have a specified default time. In this program, the console timer will count up to the maximum time of 99 minutes.

Once you have selected a program, follow the console prompts.

ENTER WEIGHT: Type in your body weight in pounds (or kilograms if your console is set to metric units).

ENTER STEP RATE: Type in your desired step rate. The StairClimber has a step rate range of 24 to 162.

ENTER TIME 5-99: Select the workout duration in one minute increments from 5 to 99.





Operation

The Quick Start Program

Provides an immediate start, without having to enter any user information. This program uses the standard default settings to calculate calories burned during a workout session.

To use the Quick Start program:

1. Press the [QUICK START] key. A message, "ENJOY WORKOUT" is displayed, the workout begins with exercise statistics accumulating.
2. During the workout:
The step rate may be changed at any time during the workout by pressing the [Level: UP] key to increase the step rate, or the [Level: DOWN] key to decrease the step rate. Any changes to the step rate will be displayed in the current flashing column. The new step rate will continue through the rest of the workout until changed using the Level keys.
3. Press [STOP] to pause the workout. Press [STOP] again to end the workout. The workout statistics will be displayed, and then the console will revert back to the "SELECT WORKOUT" message.

CALORIES BURNED: Your weight and step rate are used to calculate the number of calories burned for each minute of exercise and the total number of calories burned for the exercise session.

The Manual Program

The Manual Program allows you to control the step rate of the SC916 StairClimber during the workout, while accurately calculating exercise statistics based on your weight. The default step rate is 41 unless changed during the data entry mode. The workout profile in the display window is divided into 30 equal intervals within the selected workout time. The profile is based on the MET level, with every 1 MET equating to one vertical bar. MET level is based on a combination of step rate and time.

To use the Manual program:

1. Press the [MANUAL] key. The message, "MANUAL WORKOUT" will be displayed in the text line and the workout profile displayed in the lower display. Press [ENTER] to accept.





Operation

2. The console will display “ENTER WEIGHT - LBS” (or “ENTER WEIGHT - KG” if in Metric mode). Enter your weight using the numeric keypad and press [ENTER]. Or, press [ENTER] to accept the default value.

NOTE: Your weight is used to calculate the number of calories burned for each minute of exercise and the total number of calories burned for the exercise session.

3. The console will display “STEP RATE”. Enter the desired step rate using the numeric keypad (24 - 162) and press [ENTER]. Or, press [ENTER] to accept the default value.
4. Next, the console will display “ENTER TIME 5 – 99”. Enter the desired time and press [ENTER]. Or, press [ENTER] to select the default time.

If you press [0], then the timer will count-up from 0:00 to the maximum time of 99:00.

5. The console will display “ENJOY WORKOUT” and the timer will begin.

The step rate may be changed at any time during the workout by pressing the [Level: UP] key to increase the step rate, or the [Level: DOWN] key to decrease the step rate. Any changes to the step rate will be displayed in the current flashing column. The new step rate will continue through the rest of the workout until changed using the Level keys.

6. Press [STOP] to pause the workout. Press [Stop] again to end the workout. The workout statistics will be displayed, and then the console will revert back to the “SELECT WORKOUT” message.

The Fat Burner Program

The Fat Burner program is a 30-interval workout designed with moderate changes in intensity level designed to stimulate fat store assimilation for users on a weight control program. The profile in the center display indicates relative intensity. Any changes to the intensity level will not change the look of the remaining profile; however, the new intensity level will continue through the rest of the workout.





Operation

To use the Fat Burner program:

1. Press the [FAT BURNER] key. The message, "FAT BURNER", will be displayed on the text line with the workout profile displayed in the lower display. Press [ENTER] to accept.
2. The console will display "ENTER WEIGHT - LBS" (or "ENTER WEIGHT - KG" if in Metric mode). Enter your weight using the numeric keypad and press [ENTER]. Or, press [ENTER] to accept the default value.

Your weight is used to calculate the number of calories burned for each minute of exercise and the total number of calories burned for the exercise session.

3. The console will display "ENTER LEVEL 1-20". Enter the desired intensity level using the numeric keypad and press [ENTER]. Or, press [ENTER] to accept the default value.
4. Next, the console will display "ENTER TIME 5-99". Enter the desired time and press [ENTER]. Or, press [ENTER] to select the default time.
5. The console will display "ENJOY WORKOUT" and the timer will begin.

The intensity level may be changed at any time during the workout by pressing the [Level: UP] key to decrease the resistance, or the [Level: DOWN] key to increase the resistance. Any changes to the intensity level will not change the look of the remaining profile; however, the new intensity level will continue through the rest of the workout.

6. Press [STOP] to pause the workout. Press [Stop] again to end the workout. The workout statistics will be displayed, and then the console will revert back to the "SELECT WORKOUT" message.

CALORIES BURNED: Your weight and intensity level are used to calculate the number of calories burned for each minute of exercise and the total number of calories burned for the exercise session.





Operation

The Calorie Burner Program

The Calorie Burner program is a 30 interval workout designed for users wanting to increase their aerobic capacity. The changes of the intensity in the program are greater than the changes in the Fat Burner program, and are designed specifically to tax the cardiorespiratory system. The profile in the center display indicates relative intensity. Any changes to the intensity level will not change the look of the remaining profile; however, the new intensity level will continue through the rest of the workout.

To use the Calorie Burner program:

1. Press the [CALORIE BURNER] key. The message, "CALORIE BURNER", will be displayed on the text line with the workout profile displayed in the lower display. Press [ENTER] to accept.
2. The console will display "ENTER WEIGHT - LBS" (or "ENTER WEIGHT - KG" if in Metric mode). Enter your weight using the numeric keypad and press [ENTER]. Or, press [ENTER] to accept the default value.

Your weight is used to calculate the number of calories burned for each minute of exercise and the total number of calories burned for the exercise session.

3. The console will display "ENTER LEVEL 1-20". Enter the desired intensity level using the numeric keypad and press [ENTER]. Or, press [ENTER] to accept the default value.
4. Next, the console will display "ENTER TIME 5-99". Enter the desired time and press [ENTER]. Or, press [ENTER] to select the default time.
5. The console will display "ENJOY WORKOUT" and the timer will begin.

The intensity level may be changed at any time during the workout by pressing the [Level: UP] key to decrease the resistance, or the [Level: DOWN] key to increase the resistance. Any changes to the intensity level will not change the look of the remaining profile; however, the new intensity level will continue through the rest of the workout.

6. Press [STOP] to pause the workout. Press [Stop] again to end the workout. The workout statistics will be displayed, and then the console will revert back to the "SELECT WORKOUT" message.





Operation

The Intervals Program

The Intervals program is an interval workout containing 8 alternating rest intervals with 7 exercise intervals.

An interval cycle consists of a work phase and a rest phase. You may scale the rest intensity level and the work intensity level independently—which will be saved for the remainder of the workout.

To use the Intervals program:

1. Press the [INTERVALS] key. The message, “INTERVALS”, will be displayed on the text line with the workout profile displayed in the lower display. Press [ENTER] to accept.
2. The console will display “ENTER WEIGHT - LBS” (or “ENTER WEIGHT - KG” if in Metric mode). Enter your weight using the numeric keypad and press [ENTER]. Or, press [ENTER] to accept the default value.

Your weight is used to calculate the number of calories burned for each minute of exercise and the total number of calories burned for the exercise session.

3. The console will display “ENTER WORK RATE”. Enter the desired work rate level using the numeric keypad and press [ENTER]. Or, press [ENTER] to accept the default value.
4. The console will display “ENTER REST RATE”. Enter the desired rest rate level using the numeric keypad and press (ENTER). Or, press (ENTER) to accept the default value.
5. Next, the console will display “ENTER TIME 5–99”. Enter the desired time and press [ENTER]. Or, press [ENTER] to select the default time.
6. The console will display “ENJOY WORKOUT” and the timer will begin.

The rate level may be changed at any time during the workout by pressing the [Level: UP] key to decrease the resistance, or the [Level: DOWN] key to increase the resistance. Any changes to the rate level will only change the level in the current rest or work phase.





Operation

To change the rate level of the work phase, you must change the intensity level during a work phase. To change the rate level of the rest phase, you must change the rate level during a rest phase. Changing the rate level will not change the look of the remaining profile; however, the new intensity rate will continue through the rest of the workout.

7. Press [STOP] to pause the workout. Press [STOP] again to end the workout. The workout statistics will be displayed, and then the console will revert back to the "SELECT WORKOUT" message.

Heart Rate (HR) Zone Trainer Program

The HR Zone Trainer program allows you to exercise at a selected THR by automatically varying the intensity level (resistance) during the workout. The default THR is equal to 70% of your maximum HR which is calculated by the following equation:

$$\text{Max HR} = 215 - (\text{Age} * .75). \text{ Target HR} = \text{Max HR} * .7$$

To choose a different THR (between 100 and 180 beats per minute) at any time during the workout, use the numeric keypad to enter the new THR, followed by the [ENTER] key.

To use the HR Zone Trainer program:

1. For best results, use a telemetry HR chest belt. However, you can also use the contact HR grips located just below the console on the handlebars.

If you are using the telemetry HR method, put the chest strap on. Remember to wet the electrodes underneath the chest strap. The console must detect a HR signal to allow selection of the HR Zone Trainer program.

If you will be using contact HR, then place your hands on the contact HR grips below the console on the handlebars.

2. Press the [HR ZONE TRAINER] key. The message, "HR ZONE TRAINER", will be displayed on the text line with the workout profile in the lower display. Press [ENTER] to accept.
3. The console will then display "Checking for HR. Need HR belt or Hold HR sensors". When the console detects a valid signal it will then proceed to the next step.





Operation

- The console will display “ENTER WEIGHT - LBS” (or “ENTER WEIGHT - KG” if in Metric mode). Enter your weight using the numeric keypad and press [ENTER]. Or, press [ENTER] to accept the default value.

Your weight is used to calculate the number of calories burned for each minute of exercise and the total number of calories burned for the exercise session.

- The console will display “ENTER AGE 10 -99.” Enter your age using the numeric keypad and press [ENTER]. Or, press [ENTER] to accept the default value of 40 years old.
- The console will display “TARGET HR.” A suggested THR will be displayed, based on your the numeric keypad and then press [ENTER]. Or, press [ENTER] to accept the default value.
- The console will display “ENTER TIME 5-99.” Enter the desired time and press [ENTER]. Or, press [ENTER] to accept the default value.
- The console will display “ENJOY WORKOUT” and the timer will begin.

The following messages may be displayed during a workout:

“CHECK HR BELT”	Indicates that the telemetry HR signal has been missing for the last 30 seconds.
“HOLD HR SENSORS”	Indicates that the contact HR signal has been missing for the last 30 seconds.
“HR BELT NEEDED”	No telemetry belt signal has been sensed during the initial setup time.
“HR MODE DISABLED”	No HR signal is allowed due to the set up option that was chosen. HR monitoring is not possible. To change HR option, refer to the HR Priority section of this manual.

- Press [STOP] to pause the workout. Press [STOP] again to end the workout. The workout statistics will be displayed, and then the console will revert back to the “SELECT WORKOUT” message.

CALORIES BURNED - Your weight and intensity level are used to calculate the number of calories burned for each minute of exercise and the total number of calories burned for the exercise session.





Operation

Target Heart Rate

The THR selected by the console is based on age, and is equal to 70% of your maximum HR which is calculated by the following equation:

$$\text{Max HR} = 215 - (\text{Age} * .75)$$

$$\text{Target HR} = \text{Max HR} * .7$$

If desired, change the THR at this point by using the numeric keypad to enter the new THR, and then press [ENTER].

During a workout, change to a new THR that is between 100 and 180 beats per minute at any time by using the numeric keypad to enter the new THR, and then pressing (ENTER). The intensity level will change automatically to achieve the new THR.

More Workouts

Press the More Workouts key for several advanced program options outlined below. Press the LEVEL UP or DOWN keys to scroll through the MORE WORKOUTS program options. Press ENTER when desired program is displayed.

The Nautilus® Fit Test Program

Understanding Sub-maximal Exercise Testing

Before using the StairMaster® SC916 StairClimber for sub-maximal exercise testing, it should be noted that all sub-maximal tests make several assumptions:

- That a steady-state HR is obtained for each exercise workload.
- That a linear relationship exists between HR, oxygen uptake and workload.
- That the maximal HR for a given age is uniform.
- That the mechanical efficiency of the physical activity performed (i.e. oxygen uptake at a given workload) is the same for everyone.

It should be kept in mind that any one or all of the above mentioned assumptions may not be met during a sub-maximal exercise test. If for any reason one of the assumptions is not met, then errors in predicting $VO_{2\text{MAX}}$ (Maximum volume of oxygen consumed per unit of time) will occur.

Unfortunately, it is often quite difficult to meet all of the requirements for the four listed assumptions. For example, exercising at a given workload for only a few minutes can involve an insufficient amount of time for many individuals to achieve a true steady-state. To ensure that a steady-state has been achieved, the HR





Operation

should be measured after two minutes of exercise at a given workload and again after the third minute of exercise at that workload. These two HR's should then be compared. If a difference of more than five beats per minute between the two is found, the subject should continue to exercise at one-minute intervals at the same workload until two successive HR's differ by less than five beats per minute.

It is also important that the sub-maximal HR obtained be between 115 and 150 BPM, because it is within this HR range that a linear relationship tends to exist between HR and oxygen uptake or workload for most adults. When the HR is less than 115, many external factors (e.g. talking, laughing, apprehension, etc.) can greatly influence HR. Once the HR reaches a level between 115 and 150, external factors no longer influence HR, and a linear relationship exists. As the HR rises above 150, the HR/oxygen uptake relationship becomes curvilinear.

The third assumption involves maximal HR. Maximal HR is the greatest HR that can be measured when an individual is exercising to the point of volitional fatigue (i.e. exhaustion) during a graded exercise test. The SC916 StairClimber uses the most current published equation developed to estimate the average maximal HR as follows:

$$\text{Max Heart Rate} = 215 - (\text{Age} * .75)$$

Maximal HR can, however, vary greatly among different individuals of the same age. One standard deviation is ± 12 BPM, which means that two-thirds of the population varies an average of plus or minus 12 heart beats from the average given by a prediction equation. If an individual's age-predicted maximal HR is higher than that person's true maximal HR, then his/her estimated $\text{VO}_{2\text{MAX}}$ will be an overestimation of the correct or actual value.

The final assumption addresses the issue of mechanical efficiency. Oxygen uptake at any given work rate can vary by approximately 15% between different individuals. Therefore, individuals vary in the amount of oxygen they require to perform a certain exercise workload. Some individuals are more efficient at performing a given task than others. As a result, the average oxygen consumption associated with a given workload may vary significantly from one person to another. Thus, $\text{VO}_{2\text{MAX}}$ predicted by sub-maximal exercise tests tends to be overestimated for those who are mechanically efficient and underestimated for those who are inefficient.

The point to remember is that sub-maximal exercise testing, though not as precise





Operation

as maximal exercise testing, is not without advantages. For example, the results of such testing can provide a fairly accurate reflection of an individual's fitness status without the cost, risk, effort (on the part of the subject) and time involved in max testing. If an individual is given repeated sub-maximal exercise tests and that person's HR response to a fixed workload is found to decrease over time, it is reasonably safe to conclude that the individual has made improvements in aerobic (cardiorespiratory) fitness, irrespective of the accuracy of the $VO_{2\text{MAX}}$ prediction.

Pretest Screening

Prior to any exercise test (maximal or sub-maximal), participants should complete a brief health/medical questionnaire, have their resting blood pressure and HR measured, and provide an informed consent form. The Physical Activity Readiness Questionnaire (PAR-Q) is an example of a valid health/medical questionnaire for screening individuals prior to sub-maximal exercise testing. Canadian health and fitness practitioners have extensively (and quite successfully) used the PAR-Q to determine whether individuals should be given an exercise test. A "yes" answer to any of the following seven questions taken from the PAR-Q would disqualify a participant from taking part in an exercise test until appropriate medical clearance was obtained.

Physical Activity Readiness Questionnaire (PAR-Q)

1. Has your doctor ever said you have a heart condition and recommended only medically supervised physical activity?
2. Do you have chest pain brought on by physical activity?
3. Have you developed chest pain within the past month?
4. Do you tend to lose consciousness or fall over as a result of dizziness?
5. Do you have a bone or joint problem that could be aggravated by the proposed physical activity?
6. Has a doctor ever recommended medication for your blood pressure or a heart condition?
7. Are you aware, through your own experience or a doctor's advice, of any other physical reason against your exercising without medical supervision?



Operation

Nautilus® Sub-maximal Fit Test

The Nautilus® Fit Test is a program that estimates maximal aerobic capacity based on HR response to sub-maximal exercise.

The Nautilus® branching protocol is a series of 3-minute stages of continuous exercise at increasing intensity. The first stage is a warm-up at approximately 4 METs. The intensity of the remaining stages is based on the HR response to the warm-up. The test is designed to raise the steady state HR of the subject to at least 115 BPM. It is important to remember that two consecutive HR measurements must be obtained above 115 BPM to predict $VO_{2\text{MAX}}$. The test typically lasts from 6 to 15 minutes. The test will terminate if the HR does not continue to rise from state to stage.

In the Nautilus® protocol, each work rate is performed for 3 minutes, with HR's recorded during the final 4 seconds of the second and third minutes of each stage. If the HR's are within 5 BPM, then the HR during the last minute is plotted against the work rate, and the program advances to the next 3-minute stage. The program continues for two to four stages until two steady state HR's above 115 BPM are obtained in two consecutive stages. The line generated from the plotted points is then extended to the age-predicted maximal HR. A corresponding maximal work rate and $VO_{2\text{MAX}}$ can then be calculated.

At the end of the 3rd minute of each stage, if the HR's at the end of the 2nd and 3rd minute are not within 5 BPM of each other, then that work rate is maintained for an additional minute. At the end of the 4th minute, the HR is compared to the HR at the end of the 3rd minute. If the HR's are within 5 BPM, then the HR during the 4th minute is plotted against the work rate. If the HR at the end of the 3rd and 4th minute are not within 5 BPM, then the work rate is maintained for one more additional minute. If the HR at the end of the 4th and 5th minutes are within 5 BPM, then the HR at the end of the 5th minute is plotted against the work rate. If the HR at the end of the 4th and 5th minutes are not within 5 BPM, then the test failed.

Once two consecutive HR measurements are obtained above 115 BPM range, then the test ends successfully and the results are displayed. Estimated maximum aerobic capacity is shown in ml/kg/min and METs. Next, the results are compared to normative values for others of the same age range and gender.





Operation

To use the Fitness Test program:

1. Put the chest strap on. Remember to wet underneath the chest strap, over the electrodes.
2. Press the [MORE WORKOUTS] key. Then use the Level UP or DOWN keys to scroll through the program options. When the console displays "NAUTILUS FIT TEST", press [ENTER] to select.
3. The console will then display "ENTER WEIGHT - LBS" (or "ENTER WEIGHT - KG" if in Metric mode). Enter your weight using the numeric key keypad.
4. The console will display "ENTER AGE 10-99." Enter your age using the numeric keypad.
5. The console will display "ENTER GENDER / 1 - MALE / 2 - FEMALE. Enter your gender code using the numeric keypad.
6. The console will display "BEGIN FIT TEST".
7. The test will be terminated early, and the messages "TEST TERMINATED / TRY AGAIN LATER" will be displayed if:
 - The user stops exercising at any point during the test.
 - The [STOP] key is pressed.
 - The HR response to each work level is the same or less than the previous work level.
 - The HR never reaches 115 BPM.
 - The HR continues to rise after the fifth minute.
8. The test is complete when two consecutive steady-state HR's are obtained above 115 BPM. The test can be as short as 6 minutes, or as long as 15 minutes.

No cool down is done at the end of the test.
9. The estimated maximal aerobic capacity is displayed in METs, and VO_{2MAX} . The results are compared to normative values of the same age and gender¹ (see below), and given a fitness rating of "Low", "Fair", "Average", "Good", or "High."



Operation

Fitness Rating Norms (VO₂ MAX)

	AGE	20 – 29	30 – 39	40 – 49	50 – 59	60 +
Men	High	51.4 +	50.4 +	48.2 +	45.3 +	42.5 +
	Good	51.3 – 46.8	50.3 – 44.6	48.1 – 41.8	45.2 – 38.5	42.4 – 35.3
	Average	46.7 – 42.5	44.5 – 41.0	41.7 – 38.1	38.4 – 35.2	35.2 – 31.8
	Fair	42.4 – 39.5	40.9 – 37.4	38.0 – 35.1	35.1 – 32.3	31.7 – 28.7
	Low	39.4 or less	37.3 or less	35.0 or less	32.2 or less	28.6 or less
Women	High	44.2 +	41.0 +	39.5 +	35.2 +	35.2 +
	Good	44.1 – 38.1	40.9 – 36.7	39.4 – 33.8	35.1 – 30.9	35.1 – 29.4
	Average	38.0 – 35.2	36.6 – 33.8	33.7 – 30.9	30.8 – 28.2	29.3 – 25.8
	Fair	35.1 – 32.3	33.7 – 30.5	30.8 – 28.3	28.1 – 25.5	25.7 – 23.8
	Low	32.2 or less	30.4 or less	28.2 or less	25.4 or less	23.7 or less

¹ The American College of Sports Medicine, Guidelines for Exercise Testing and Prescription, 6th Edition, Lippincott Williams & Wilkins, Philadelphia, PA, 2000, p. 77.

Calorie Goal

The Calorie Goal program allows the user to define a target number of calories to burn during their workout.

To use the Calorie Goal Program:

1. Press the MORE WORKOUTS key. Then use the Level UP or DOWN keys to scroll through the program options. When the console displays “CALORIE GOAL”, press [ENTER] to accept.
2. The console will then display “ENTER WEIGHT – LBS” (or “ENTER WEIGHT – KG” if in Metric mode). Enter your weight using the numeric keypad and press [ENTER]. Or, press [ENTER] to accept the default value.
3. The console will display “ENTER STEP RATE”. Enter the desired intensity level using the numeric keypad and press [ENTER]. Or, press [ENTER] to accept the default value.
4. The console will then display “ENTER CALORIES”. Enter the desired calorie value using the numeric keypad and press [ENTER]. Or, press [ENTER] to accept the default value.
5. The console will display “ENJOY WORKOUT” and the timer will begin.



Operation

HR Interval Program

The HR Interval program allows the user to define an exercise Target HR, time at exercise THR, recovery THR and total exercise time.

To use the HR Interval Program:

1. Press the MORE WORKOUTS key. Then use the Level UP or DOWN keys to scroll through the program options. When the console displays "HR INTERVALS", press [ENTER] to accept.
2. The console will then display "Checking for HR. Need HR belt or Hold HR sensors". When the console detects a valid signal it will then proceed to the next step.
3. The console will then display "ENTER WEIGHT – LBS" (or "ENTER WEIGHT – KG" if in Metric mode). Enter your weight using the numeric keypad and press (ENTER). Or, press [ENTER] to accept the default value.
4. The console will display "ENTER AGE 10 - 99." Enter your age using the numeric keypad. Or, press [ENTER] to accept the default value of 40 years old.
5. The console will display "WORK TARGET HR." A suggested THR will be displayed, based on your age. Press [ENTER] to accept the calculated THR, or enter a different THR using the numeric keypad and then press [ENTER].
6. The console will display "ENTER WORK TIME". This is the amount of time you want to exercise in the work THR zone. Enter desired work time using the numeric keypad and press (ENTER).
7. The console will then display "REST TARGET HR". A suggested THR will be displayed, based on your age. Press (ENTER) to accept the calculated THR, or enter a different THR using the numeric keypad and then press (ENTER).
8. The console will display "ENTER REST TIME". This is the amount of time you want to exercise in the rest THR zone. Enter desired rest time using the numeric keypad and press (ENTER). Or press (ENTER) to accept the default value.
9. The console will then display "ENTER TIME". Enter desired total workout time using the numeric keypad and press "ENTER". Or, press (ENTER) to accept the default value.
10. The console will display "ENJOY WORKOUT" and the timer will begin.





Operation

Random Play Workout

The Random Play Workout is a program that randomly changes the intensity throughout the workout time.

1. Press the MORE WORKOUTS key. Then use the Level UP or DOWN keys to scroll through the program options. When the console displays "RANDOM PLAY", press [ENTER] to accept.
2. The console will then display "ENTER WEIGHT – LBS" (or "ENTER WEIGHT – KG" if in Metric mode). Enter your weight using the numeric keypad and press (ENTER). Or, press [ENTER] to accept the default value.
3. The console will display "ENTER LEVEL". Enter the desired average intensity level using the numeric keypad and press (ENTER). Or, press [ENTER] to accept the default value.
4. The console will then display "ENTER TIME". Enter the desired time and press (ENTER). Or, press [ENTER] to accept the default value.
5. The console will display "ENJOY WORKOUT" and the timer will begin.

Custom Intervals Workout

In the Custom Intervals workout, users can create a custom interval program by entering Rest Level and Time, Work Level and Time, and total # of intervals.

To use the Custom Intervals Program:

1. Press the MORE WORKOUTS key. Then, use the Level UP or DOWN keys to scroll through the program options. When the console displays "CUSTOM INTERVALS", press [ENTER] to accept.
2. The console will then display "ENTER WEIGHT – LBS" (or "ENTER WEIGHT – KG" if in Metric mode). Enter your weight using the numeric keypad and press (ENTER). Or, press [ENTER] to accept the default value.
3. The console will display "ENTER WORK RATE". Enter the desired work rate using the numeric keypad and press (ENTER). Or, press [ENTER] to accept the default value.
4. The console will then display "ENTER WORK TIME". Enter the desired time and press (ENTER). Or, press [ENTER] to accept the default value.





Operation

5. The console will display "ENTER REST RATE". Enter the desired rest rate using the numeric keypad and press (ENTER). Or, press [ENTER] to accept the default value.
6. The console will then display "ENTER REST TIME". Enter the desired time and press (ENTER). Or, press [ENTER] to accept the default value.
7. The console will display "# OF INTERVALS". Enter the desired number of intervals using the numeric keypad and press (ENTER). Interval range is 1-15. Or, press [ENTER] to accept the default value.
8. The console will display "ENJOY WORKOUT" and the timer will begin.

The Work/Rest Rate may be changed at any time during the workout by pressing the [Level: UP] key to decrease the resistance, or the [Level: DOWN] key to increase the resistance. Any changes to the work/rest rate level will only change the level in the current recovery or exercise phase.

To change the step rate of the exercise phase, you must change the step rate during an exercise phase. To change the step rate of the recovery phase, you must change the step rate during a recovery phase. Changing the step rate will not change the look of the remaining profile; however, the new step rate will continue through the rest of the workout.

CPAT Test

The first phase is a warm up interval at intensity of 56 step/min and lasts 20 seconds. At the end of the first interval the time counter will reset to zero.

The second phase continues through nine 20 second intervals at an intensity of 68 steps/min. The CPAT Stair Climb Test has a total of 10 intervals and lasts for 3 minutes, 20 seconds (including warm up).

To use the CPAT Test Program:

1. Press the MORE WORKOUTS key. Then, use the Level UP or DOWN keys to scroll through the program options. When the console displays "CPAT TEST", press [ENTER] to accept.
2. The console will then display "BEGIN FIT TEST".





Operation

Options During a Workout

After the message, "Enjoy Workout", is displayed, your workout statistics will begin to accumulate. The exercise statistics include, in order:

- TIME
- MILES
- CAL/HR
- STEPS/MIN
- FLOORS
- WATTS
- METS

Target Heart Rate (in HR Control programs only)

The 20 x 30 brickyard in the lower half of the display will show the exercise profile of the workout program selected. Each column represents an equal portion of the total workout and the flashing column will advance across the brickyard as you progress through your workout.

Changing Step Rate (SR) or Target Heart Rate (THR) During a Workout

During the workout, the SR may be changed at any time during the workout by pressing the [Level: UP] key to decrease the resistance, or the [Level: DOWN] key to increase the resistance. The console will display "STEP RATE".

In HR Control programs, you can use the numeric keys to change the THR. If the user presses a numeric key in a HR Control program, then the message line will display "TARGET HR".

Once you enter your desired THR, press [ENTER] to accept, and the console will gradually change the resistance to move you to the new THR.

Target Heart Rate (THR)

The WORK THR selected by the console is based on age, and is equal to 80% of your maximum HR which is calculated by the following equation:

$$\text{Max HR} = 215 - (.75 * \text{Age})$$

$$\text{Target HR} = \text{Max HR} * .8$$

If desired, change the THR at this point by using the numeric keypad to enter the new THR, and then press [ENTER]. Change to a new THR (between 100 and 180 beats per minute) during a workout by using the numeric keypad to enter the new THR, and then pressing [ENTER].





Operation

The REST THR selected by the console is based on age, and is equal to 65% of your maximum HR which is calculated by the following equation:

$$\text{Max HR} = 215 - (.75 * \text{Age})$$

$$\text{Target HR} = \text{Max HR} * .65$$

If desired, change the THR at this point by using the numeric keypad to enter the new THR, and then press [ENTER].

Pausing Your Workout

The program automatically enters the PAUSE state from a workout when the STOP key is pressed. The workout will be suspended, and the program will display the following alternating messages every 3 seconds for up to 2 minutes: "WORKOUT PAUSED. PRESS STOP OR START".

When the program enters a PAUSE state, the interval timer begins to count down from 2 minutes to show you the time remaining in the pause condition.

To leave the PAUSE state:

- At the end of the two minutes count down, the current workout ends, the accumulated exercise statistics are scrolled, and the program returns to the opening message.
- If the user presses [STOP], then the program ends, the accumulated exercise statistics are scrolled, and the program returns to the opening message.
- If the user presses the [QUICK START] key, then the workout proceeds from where it was suspended.

End of Your Workout

The program is at the end of the workout when the workout time is completed, or from the PAUSE state when the [STOP] key is pressed. At this point, each workout statistic is scrolled with averages calculated and displayed for TIME, DISTANCE, CAL, Ave CAL/HR, Ave STEPS/MIN, FLOORS, Ave WATTS, Ave METS.

After the statistics are scrolled, the program returns to the opening message. If you want to replay the exercise statistics, press the Display LOCK/UNLOCK key, and each exercise statistic will be scrolled once for 3 seconds.





Operation

HEART RATE MONITORING

HR monitoring helps users monitor their levels of exertion by displaying the HR during exercise. There are two methods of monitoring HR on the Commercial Series SC916 StairClimber:

- Telemetry (e.g. using a Polar® or Polar-compatible transmitter belt). A Polar-compatible HR chest belt transmits the heart beat signal to the receiver in the display. The display shows the HR in beats per minute and uses the HR value in HR control mode.
- Contact HR (handgrip). Sensors on the handgrip detect HR and display it on the controller.



Pacemaker users should not use the telemetry transmitter without first consulting with their doctor.

Telemetry Heart Rate

The telemetry HR monitoring system consists of the receiver, located in the display, and a transmitter belt (purchased separately) worn across your chest. The monitoring function is activated as soon as you strap on the chest belt and step within range of the receiver in the machine. Two electrodes on the underside of the chest belt sense the HR signal and send it to the receiver. The far right decimal point in the HR Display pulses to indicate that the display is receiving a valid signal. A microprocessor in the controller calculates the HR and shows it, in BPM, on the display.

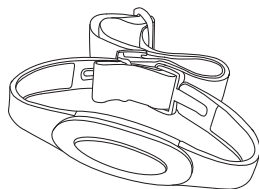

Before you put the transmitter belt on, wet the two electrode patches (the grooved rectangles on the reverse side of the belt). Secure the transmitter belt as high under the pectoral muscles (chest) as is comfortable. The transmitter belt should fit snugly and comfortably, and allow normal breathing.

After the initial belt signal is detected, the display will enter a validation phase in which four good heart beat signals lasting four seconds are required before locking on telemetry HR signals for the duration of the workout session.

If your HR is not being displayed, try the following:

- Move closer to the display.
- Tighten the elastic band on the chest belt.
- Adjust the belt higher or lower on your chest.





Operation

- Remoisten the electrodes.
- Test your chest strap with a machine that you know is working, or with a HR watch that you know is working.

Maintaining the Transmitter Belt

Clean the chest belt regularly with mild soap and water, then dry thoroughly. Residual sweat and moisture keeps the transmitter active and will drain the battery in the transmitter. Do not use abrasives or chemicals such as steel wool or alcohol for cleaning, as they can damage the electrodes permanently. Replacement belts can be purchased from an Authorized Nautilus Fitness Retailer or at www.nautilus.com.

Contact HR

Through the use of stainless steel sensors built into the handle bar and using sophisticated software, HR can be checked at any time during a workout. As with the wireless telemetry chest belt, the HR is shown on the display in the same manner.

The contact HR system's ability to detect a HR signal is influenced by several factors. Movement of the muscles of the upper body produces an electrical signal (muscle artifact) that will interfere with the detection of the HR signal by the sensors. Movement of the hands while they are in contact with the sensors also produces interference. Calluses and hand lotion act as an insulating layer to reduce the signal strength. Also, the EKG signal generated by some individuals is not strong enough to be detected by the sensors. These individuals should opt for the telemetry method of HR monitoring.

Contact HR input signals are acquired only during contact between your hands and the stainless steel sensors on the handrails. To use the contact HR feature, place your hands around the handles so that your hands touch both the top and the bottom of the sensors. After the initial contact HR signal is detected, the controller will enter a validation phase requiring a good heart beat signal within 10 to 15 seconds, or until the system acquires a valid signal. During the validation phase the controller will not recognize telemetry HR signals. The controller will display a heart icon.

If, during exercise, the HR displayed is erratic, it may be helpful to remove your hands from the handles, wipe them and place them back on the handles. In all programs, the HR is shown automatically in the display window the first time the sensors are touched.





Operation

HEART RATE PRIORITY

Both contact HR and telemetry (e.g., Polar®) HR signal detection are available. The default priority of HR input is "EITHER INPUT."

Locked/Non-Locked HR Signal Options

The "EITHER INPUT" option means that the HR source signal is not fixed during the workout session (if the signal is lost either input will be valid). If the "LOCKED INPUTS" option is selected then the HR source signal is locked on the first detected signal during the workout. To set a HR signal input, or to turn off the HR option all together, perform the following steps:

1. On the console keypad, press [Level: UP], [3], [ENTER]. At this point the screen will display "CUSTOMIZE". Use the [Level: UP] key until "HR INPUTS" appears, then press [ENTER] to select th option.
2. There are six options to handle HR input signals. Press the [Level: UP] and [Level: DOWN] keys to scroll through the options until you find the option that you want. Press the [ENTER] key to select that option.

The options are as follows:

LOCKED INPUTS

Allows either telemetry or contact HR signals to be detected. Once the console has detected a valid input signal it will lock out the opposite type of signal for the duration of the workout session. For example, if you start out using contact HR then you are limited to using only contact HR during your workout session, even if the signal is lost while performing the workout, and vice-versa.

EITHER INPUT

Allows either telemetry or contact HR signals to be detected. Does not lock out a particular input signal for the entire workout. This option will detect either input signal during a workout session, but only one at a time, and only until the other signal terminates.

TELEMETRY ONLY

Locks out contact HR signals and will only detect telemetry signals.

HAND ONLY

Locks out telemetry signals and will only detect contact HR signals.





Operation

BOTH HR OFF

Turns off the ability to detect any HR signal. Used in rare situations where there is excessive interference with the HR signals. During workouts where HR is necessary, such as the HR Zone Trainer and the Fitness Test, the console will pick up telemetry HR signals so that the programs are not disabled.

HAND HR PGRM OFF

Means that the HR control programs require a telemetry strap to work.

No single fitness program is suitable for all. All fitness programs should be designed by fitness professionals who are trained to tailor the program to the individual goals and fitness levels of each client. The following information on exercise intensity, duration, and frequency is based on averages and is included here only as a guideline for use by fitness professionals. Programs should be altered for comfort and safety when necessary.





Operation

CONSOLE CODES

There are 4 groups of console codes as follows: Customization (codes starting with 2 or 3), Machine Status (codes starting with 4), Diagnostic (codes starting with 6 or 7), and Configuration (codes starting with 8). Each group of codes is defined below. To access these console codes and the options within each group, follow the instructions for each section.

Customizing the SC916 StairClimber

You can customize several parameters on the SC916 StairClimber to conform to your individual requirements, including changing the workout default values and setting custom parameters such as time limits, changing screen contrast, changing language, and changing units.

To change the workout default values:

1. Press [Level: UP], [2], [ENTER]. The console will display “DEFAULTS”.
2. Press [Level: UP] or [Level: DOWN] to scan through the default choices. Select the option you want to change by pressing [ENTER]. Then use the [Level: UP] or [Level: DOWN] keys or the numerical keypad to change the value for the selected option. Press [ENTER] to accept the choice for that option.

The Defaults options are as follows:

Change default weight

Use the numeric keypad or [Level: UP] or [Level: DOWN] keys to change the desired default weight for your facility. Press [ENTER] to accept the new value.

Change default workout time

Use the numeric keypad or [Level: UP] or [Level: DOWN] keys to change the desired default workout time between 5 and 99 minutes. Press [ENTER] to accept the new value.

Change default age

Use the numeric keypad or [Level: UP] or [Level: DOWN] keys to change the desired default age used to calculate target HR. Valid age range is between 10 and 99. Press [ENTER] to accept the new value.





Operation

Change default % Target HR

Use the numeric keypad or [Level: UP] or [Level: DOWN] keys to change the desired target HR % value based on maximum HR. This is used to calculate the target HR value based on the % of maximum HR. Valid target HR % is between 10% and 90%. Press [ENTER] to accept the new value.

Change default Starting Level

Use the numeric keypad or [Level: UP] or [Level: DOWN] keys to change the desired default level between 1 and 20. Press [ENTER] to accept the new value.

Change default Step Rate

Use the numeric keypad or [Level: UP] or [Level: DOWN] keys to change the desired default level between 26 and 162. Press [ENTER] to accept the new value.

To customize the console for your use:

1. Press [Level: UP], [3], [ENTER]. The console will display "CUSTOMIZE."
2. Press [Level: UP] or [Level: DOWN] to scan through the customize choices. Select the option you want to change by pressing [ENTER]. Then, use the [Level: UP] or [Level: DOWN] keys or the numerical keypad to change the value for the selected option. Press [ENTER] to accept the choice for that option.

The Customize options are as follows:

Cool Down

Use the [Level: UP] and [Level: DOWN] keys or the numeric keypad to enter the desired cool down time in minutes. Press [ENTER] to select your option.

Select Stats

Use the [Level: UP] or [Level: DOWN] keys to select the desired "Stat". Press [ENTER] twice to select your option.

Max time limit

Use the numeric keypad to enter the desired time limit between 20 and 99 minutes. Press [ENTER] to accept the new time limit. Press [0] and the display will read "TIME LIMIT OFF".





Operation

Change units

Use the [Level: UP] and [Level: DOWN] keys to toggle between USA units and Metric units. Press [ENTER] to select your option.

HR inputs

See HR Priority in the previous section for details of the choices.

Language

Use the [Level: UP] and [Level: DOWN] keys to view the choices (English, German, French, Spanish, Italian, Dutch, Japanese). Press [ENTER] to select your option.

Adjust upper LCD screen contrast

Use the [Level: UP] and [Level: DOWN] keys to increase or decrease the contrast level of the upper LCD. Press [ENTER] to select your option.

Adjust lower LCD screen contrast

Use the [Level: UP] and [Level: DOWN] keys to increase or decrease the contrast level of the upper LCD. Press [ENTER] to select your option.

Auto Repeat (Not Used)

3. To exit "CUSTOMIZE", press the [CLEAR] key.

Machine Status Codes

To view maintenance information such as the run time in hours, number of workouts and distance, as well a machine type and software revision:

1. Press [Level: UP], [4], [ENTER]. The console will display "MACHINE STATUS"
2. Press [Level: UP] or [Level: DOWN] to scan through the choices to view. Press [CLEAR] to exit the machine status codes.

The machine status options are as follows:

Machine run time in hours

Display the machine run time in hours. The console will display "RUN HOURS #####".

Number of workouts

Display the number of times a workout key has been pressed. The console will





Operation

display "WORKOUTS ####".

Floors

Display the total floors traveled. The console will display "FLOOR #####".

Software revision

Display the console software revision number. The console will display "CONS 41375-###".

Machine type

Display the machine type the console is currently configured to. The console will display "STAIRCLIMBER" or other machine type.

Machine run time in hours since last cleared (used for maintenance)

Display the machine run time since last cleared. The console will display "MAINT HOURS #####". This will provide the number of hours between service or maintenance calls. The machine run time is reset to zero in the following Diagnostics section.

3. To exit "MACHINE STATUS", press the [CLEAR] key.

Diagnostic Codes

Diagnostic codes are used to test various components of the machine such as the display, keyboard, serial port, alternator, and tachometer, as well as viewing the error log information and resetting the time between service or maintenance calls.

To run diagnostics and view diagnostic information:

1. Press [Level: UP], [6], [ENTER]. The console will display "DIAGNOSTICS"
2. Press [Level: UP] or [Level: DOWN] to scan through the choices. Select the option you want to view by pressing [ENTER].

The diagnostic options are as follows:

Test display

To test the LCD display, press [ENTER] when the message, "DISPLAY TEST" is displayed. The console screen alternates turning on all LCD segments and a representative program screen. Verify that all LCD segments turn on.





Operation

Test keyboard

To test all the keys on the keyboard, press [ENTER] when the message, "KEY TEST" is displayed. Then, press any key on the keyboard and that key's name will be displayed in the text line. Press [CLEAR] as the last key to exit this test.

Test serial port

To test the serial port, press [ENTER] when the message, "SERIAL TESTS" is displayed. This test performs a serial loop back test. Select the CSAFE RS-232 selection. You will need a loop-back test **cable** inserted into the appropriate connector port to successfully run this test. Console will display either "PASS" or "FAIL".

Test alternator

To test the machine's alternator, press [ENTER] when the message, "ALT TEST" is displayed. This test verifies the alternator field routines through the console. Position yourself on the machine and press [Level: UP] for "field on". After exercising briefly you should build up resistance. For "field off", press [Level: DWN].

Test tach response

To test the machine's tachometer, press [ENTER] when the message, "TACH TEST" is displayed. Start exercising on the machine. The console should regulate the alternator resistance based on the tach signal to maintain approximately 2,000 RPMs while you are exercising. If not, there is a possible problem in the AC tap or field circuit. Check the alternator, the AC tap wire, the field wire, the diode, the terminal posts, and the main **cable**.

I/O Test

Press [ENTER] when the message "I/O TEST" is displayed. The AUX and B+ values represent the current and voltage delivered from the alternator respectively. AUX is scaled by 1000 and B+ is scaled by 300. These values will increase with the speed of the alternator (note that both values will reach 0 if the alternator is left at rest). The "---" string is displayed at all times since the StairClimber does not require a magnetic key.

A Sensor B

N/A

3. To exit "DIAGNOSTICS", press the [CLEAR] key.





Operation

To review the error log and reset the service timer:

1. Press [Level: UP], [7], [ENTER]. The console will display "MAINTENANCE LOG".
2. Press [Level: UP] or [Level: DOWN] to scan through the choices. Select the option you want by pressing [ENTER].

Error log

To display the machine's error log, press [ENTER] when the message, "ERROR LOG", is displayed. The console will report various error messages in the display window. The total amount of errors will be displayed in the upper right window. Note that only the highest priority reported error will be displayed. Errors are handled in two ways. First, as a non-fatal "WARNING" which will display the text message but continue system operation until you press the [CLEAR] key. The second way is a fatal "ERROR" which will stop the exercise and return the system to an idle intensity state. The console will display the error text and not let you restart the program unless power has been turned off and then back on. There are 16 error entries available.

Reset service time

To reset the time between service or maintenance calls, press [ENTER] when the message, "MAINT HOURS" is displayed. Press the [0] key, then [ENTER] to reset..

QA ID

N/A

3. To exit "MAINTENANCE LOG", press the [CLEAR] key.

Configuration Codes

1. Press [Level: UP], [8], [ENTER]. The console will display "CONFIGURATION".
2. Press [Level: UP] or [Level: DOWN] to scan through the choices. Select the option you want by pressing [ENTER].





Operation

Change Machine

Changes the machine type from StairClimber, StepMill® machine, Bike rev B, Bike rev A or Elliptical. Scroll through the screen until “CHANGE MACHINE” is displayed. Press (ENTER), then press [Level: UP] or [Level: DOWN] to scan through the choices. Select the machine type you want by pressing [ENTER].

Reset Data Set Up

Scroll through the screen until “RESET DATA SET UP” is displayed and press (ENTER). All customized customer settings will be cleared.

NOTE: The Console will need to be reconfigured.

Clear Error Log

Scroll through the screen until “CLEAR ERROR LOG” is displayed and press (ENTER). The word “DONE” will appear and all accumulated errors in the Error Log will be cleared.

Reset Console

Scroll through the screen until “RESET CONSOLE” is displayed and press (ENTER). Resets all defaults to original manufacturing settings..

NOTE: The Console will need to be reconfigured.





Maintenance

Maintenance Records

For ease of maintenance the SC916 StairClimber console will keep track of hours, number of workouts, time between last servicing, etc. You can quickly access any of the custom menus by pressing [LEVEL: UP], [4], [ENTER]. The console will then display "MACHINE STATUS." Use the [Level: UP] and [Level: DOWN] keys to scroll through the options. For details, refer to the Machine Status Console Codes in the previous section.

Resetting the Maintenance Hour Timer

After each maintenance period reset the counter. Press [LEVEL: UP], [7], [ENTER]. Then use the Level keys to scroll through the options. When "MAINT HOURS" is displayed, press [ENTER]. Press the [0] key, then press [ENTER]. Press [CLEAR] to return to the opening screen.

Moving your SC916 StairClimber

Stand in front of the machine and grasp the handlebars. Pull down until the transport wheels are in contact with the ground.

Note: Do not push down on the plastic shroud with your feet when tilting the machine up to contact the transport wheels with the ground. Use the stabilizer bars instead, to avoid any damage to the plastic covers.

The machine can now be rolled on the transport wheels.

Note: The transport wheels are intended for indoor use only and should never be rolled on concrete or asphalt surfaces.

Initial Service

Upon receiving your machine, use a soft, clean towel to wipe off the dust, which may have accumulated during shipping. Your new machine will require minor assembly. Refer to the Assembly Manual for details.



The safety and performance of this product can be maintained only if it is inspected regularly for damage and wear.

Pay particular attention to components most susceptible to wear such as Contact Heart Rate housing, Foot pedal pads and Lower side covers.

Remove any damaged machine from service and replace damaged components immediately.

Direct any question regarding maintenance or its function to a qualified Nautilus Technician. For contact information please see the Important Contact Numbers page at the back of this manual.



Maintenance Schedule

	Daily	Weekly	Monthly	Every 3 mos.	Comments
General Maintenance					
Check Safety & Warning Labels	X				
Spot Check Step Chains	X				
Alternator Belt Tension			X		Tension to 30-45 inlbs
Lubrication					
Drive and Step Chains			Or every 300 hrs.		30W Oil
Leveling and Pedal Arm Shafts				Or every 900 hrs	Multi-Purpose grease
Spring Pulley and Pedal Shafts				Or every 900 hrs	Multi-Purpose grease
Cleaning					
Clean Console	X				Clean with a water dampened cloth and wipe dry after cleaning.
Clean Lower Side Covers	X				Clean exterior with soap and water or a diluted household cleaner.
Clean and Lubricate Pedal Springs		X			Clean, then wipe with lightly oil soaked rag.

Cleaning

1. Do not use glass cleaners or any other household cleaners on the console. Clean the console daily with a water-dampened cloth and wipe dry after cleaning.
2. Clean the exterior of the machine daily using soap and water or a diluted, non-mineral based household cleaner such as Fantastic®.

Inspection

1. Inspect the frame for any rust, bubbling, or paint chips during the daily cleaning. The salt in perspiration can damage the unpainted surfaces. Repair the damaged area with a touch-up paint kit purchased from Nautilus® (call Customer Service for order information).

Parts and Service

Regular and scheduled maintenance will prolong the life of your Nautilus® equipment. Only use genuine Nautilus® replacement parts. The Nautilus® Customer Service Team invites you to call in your order for replacement parts.



Maintenance

Checking the Battery Charge

1. Using your multimeter, touch the red lead to the positive terminal a diluted, non-min of the battery and the black lead to the negative terminal.
2. If the voltage level is less than 6.1 VDC, charge the battery.

Charging the Battery Back-Up

The StairMaster® Commercial Series SC916 StairClimber is selfpowered (cordless) with a rechargeable battery back-up. Typically, the StairClimber can be operated without plugging in the external power supply. If, however, the console flickers during operation or the console display does not light up while using the machine, then use the external power supply to recharge the battery back-up.

The external power supply is supplied with the unit and plugs into a standard 115 volt, 15 amp outlet, or a 220 volt, 10 amp outlet. (All major voltage plugs are available.) The plug-in for the external power supply is located in the front of the machine at the base.

IMPORTANT: If installing the optional LCD Monitor, refer to the NV915 installation manual at this time.

Plug the wall pack external power supply into the connector and charge the battery for approximately 24 hours and then recheck it. It is okay to use the machine while the external power supply is connected.

The console will power on as user starts to move the pedals of the machine, and will stay lit for up to 60 seconds in pause mode. The console will power off after 60 seconds of stopping exercise. The console will power on and remain powered whenever the external power supply is connected.

Battery Disposal

When ordering new batteries, you will need to properly dispose of (recycle) your old lead-acid batteries. Most federal and state regulations require lead-acid batteries to be recycled. Do not throw away old batteries. Lead is a toxic heavy metal, hazardous to living organisms.

Recycling

Do not dispose of this product as refuse. This product is to be recycled. For information on the proper method of disposal contact a Nautilus Customer Service Representative.

If you have questions, contact the Customer Service Department at 800-NAUTILUS (800-628-8458), (41) (26) 460 77 77 (International Office) or refer to the Important Contact Numbers section in this manual.

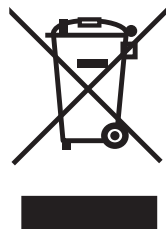

Warranty Information

All Nautilus® exercise products are warranted to the commercial market purchaser to be free from defects in materials and workmanship. Warranty coverage valid to the original purchaser only and proof of the purchase will be required. Any product sold or placed in an application not recommended by Nautilus, Inc. will void any warranty coverage set forth by Nautilus, Inc. warranty policies and procedures.

Time Period

15 Years - Frame

3 Years - Mechanical and electrical parts

1 Year - Labor

1 Year - Wear items

Warranty terms may differ outside the USA.

This Warranty Does Not Cover:

1. Users weighing more than 300 lbs (136 kg).
2. Any damage, failure or loss caused by accident, misuse, neglect, abuse, improper assembly, improper maintenance or failure to follow instructions or warnings in Owner's Manual.
3. Use of product in a manner or environment for which it was not designed.

Limitations:

The foregoing warranties are in lieu of and exclude all other warranties not expressly set forth herein, whether expressed or implied by operation of law or otherwise, including, but not limited to, warranties of merchantability or fitness for a particular purpose. Nautilus, Inc. shall in no event be liable for incidental or consequential losses, damages or expenses in connection with its exercise products. Nautilus' liability hereunder is expressly limited to the replacement of goods not complying with this warranty or, at Nautilus' election, to the replacement amount of the purchase price of the exercise product in question. Some states do not permit the exclusion or limitation of implied warranties or incidental or consequential damages, so the preceding limitations and exclusions may not apply to you.

Procedures:

Warranty service will in most cases be performed by an authorized Nautilus® Fitness Dealer or Service Technician. The original purchaser must provide proof of purchase, Service calls and/or transportation to and from the Nautilus Dealer is the responsibility of the purchaser.



Warranty Information

1. Nautilus, Inc. will have the option to repair or replace any exercise product, which requires service.
2. Nautilus, Inc. will replace any equipment frame that is structurally defective with a new frame or replace the unit with a unit of equal value.
3. Nautilus, Inc. is not responsible for dealer labor charges for the component changeovers completed after the labor related warranty period stated herein.
4. If you elect to repair an exercise product or part yourself, using the services of someone other than an authorized Nautilus® Fitness Dealer or Service Technician, or use a replacement part not supplied by Nautilus, Inc., Nautilus, Inc. shall not be liable for any cost, damage, failure or loss caused by the use of such unauthorized service or parts.



Contact Information

UNITED STATES OFFICES:

E-mail: customerservice@nautilus.com

TECHNICAL/CUSTOMER SERVICE

Phone: 800-NAUTILUS (800-628-8458)

Fax: (877) 686-6466

E-mail: cstech@nautilus.com

CORPORATE HEADQUARTERS

Nautilus, Inc.

World Headquarters

16400 SE Nautilus Drive

Vancouver, Washington, USA 98683

Phone: (800) NAUTILUS (800) 628-8458

CANADA OFFICE:

NAUTILUS FITNESS CANADA, INC.

925 Keewatin Street

Winnipeg, MB, Canada R2X 2X4

Phone: (866) 381-5996

Fax: (800) 532-6934

E-mail: nfcpartsandservice@nautilus.com

Please supply the serial number of your machine and the date of purchase when you call Nautilus. Use the space in the boxes below to write down this information. To find the serial number on your machine, refer to the Safety Warning Label information page. Dial the number of the office close to you.

Please record the following information for future reference.

Serial Number

Date of Purchase

INTERNATIONAL OFFICES:

For technical assistance and a list of distributors in your area, please call or fax one of the following numbers.

INTERNATIONAL CUSTOMER SERVICE

Nautilus International S.A.

Rue Jean Prouvé

1762 Givisiez / Switzerland

Tel: (41) (26) 460 77 77

Fax: (41) (26) 460 77 70

E-mail: technics@nautilus.com

GERMANY and AUSTRIA

Nautilus Deutschland GmbH

Albin-Köbis-Str. 4

51147 Köln

Tel.: (49) 02203 2020 0

Fax: (49) 02203 2020 45 45

ITALY

Nautilus Italy S.r.l., Via della Mercanzia, 103

40050 Funo di Argelato - Bologna

Tel: (39) 051 664 6201

Fax: (39) 051 664 7461

SWITZERLAND

Nautilus Switzerland SA

Rue Jean-Prouvé 6,

CH-1762 Givisiez

Tel: (41) 026 460 77 66

Fax: (41) 026 460 77 60

UNITED KINGDOM

Nautilus UK Ltd

Nautilus UK, 4 Vincent Avenue,

Crownhill, Milton Keynes, Bucks, MK8

0AB

Tel: (44) 1908 267 345

Fax: (44) 1908 567 346

CHINA

Nautilus Representative Office

Nautilus, Shanghai, 7A No.728, Yan'an Rd(West),

200050 Shanghai, China

Tel: (86) 21 523 707 00

Fax: (86) 21 523 707 09



StairMaster®

©2008. Nautilus, Inc. All rights reserved. Nautilus, the Nautilus Logo, Universal, the Universal Logo, Bowflex, StairMaster, StairMaster Logo, and Nautilus Institute are either registered trademarks or trademarks of Nautilus, Inc. Schwinn and the Schwinn Quality Seal are registered trademarks. All other trademarks are owned by their respective companies.

Nautilus, Inc., World Headquarters, 16400 SE Nautilus Drive, Vancouver, WA 98683 1-800-NAUTILUS www.nautilus.com

Nautilus® Bowflex® Schwinn® Fitness StairMaster® Universal® Nautilus Institute®

